

AN INTRODUCTION TO BUtech BALL VALVES

BuTech ball valves are available in 2-, 3-, 4- and 5-way designs with an infinite combination of connections including male and female NPT, low-pressure compression fittings, medium- and high-pressure tube ends, medium- and high-pressure female, JIC 37° flare, SAE O-ring boss, socket-weld, butt-weld, and metric connections. They are available with special seal materials or manufactured from any machinable metal for extreme applications. They can also be fitted with pneumatic or electric actuators for remote control.

Features:

- Pressures to 20,000 PSI (1380 bar) at 72°F (22°C)
- Pressure loaded seats assure positive sealing
- Blowout-proof stem and ball provides maximum safety
- Choice of replaceable connections for installation versatility
- Straight-through flow path minimizes pressure drop
- Quarter-turn operation accommodates quick open and close needs
- Flow indicating handle indicates valve position at a glance
- Bi-directional flow capabilities

Applications:

All types of instrumentation

Laboratories

Refineries

Hydraulic and pneumatic piping

Chromatography

Gauge shut-off and vent

Control panels

High purity systems

Chemical research

Food processing

Pilot plants

Water blasting

Gas analysis

Test Stands

Moderate vacuum systems

Down-hole control systems on off-shore drilling platforms

Materials of Construction:

Standard materials of construction include 316 cold-worked stainless steel, 17-4PH, PEEK, Viton, virgin teflon and glass-filled teflon. These valves may also be produced in any machinable metal with special seal materials. Please consult factory.

Selecting the Proper Ball Type

BuTech ball valves offer a variety of flow configurations. See page BV-20 for additional information.

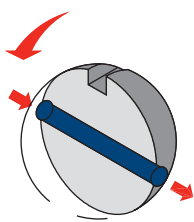

2-way

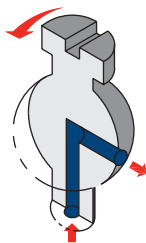

3-way & 5-way

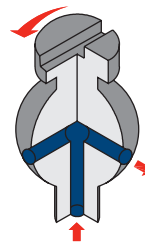

3-way

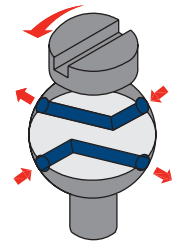

4-way

***CAUTION:** The maximum allowable working pressure (MAWP) of the valve does not exceed the MAWP of the series or the selected connection, whichever is less.

All dimensions are for reference only and are subject to change.
Dimensions in parentheses are millimeters (mm).

上海兆帕流体动力有限公司 / Shanghai MPA Fluid Power Co.,Ltd.
Web: www.mpapower.com / E-mail: info@mpapower.com



ORDERING INFORMATION

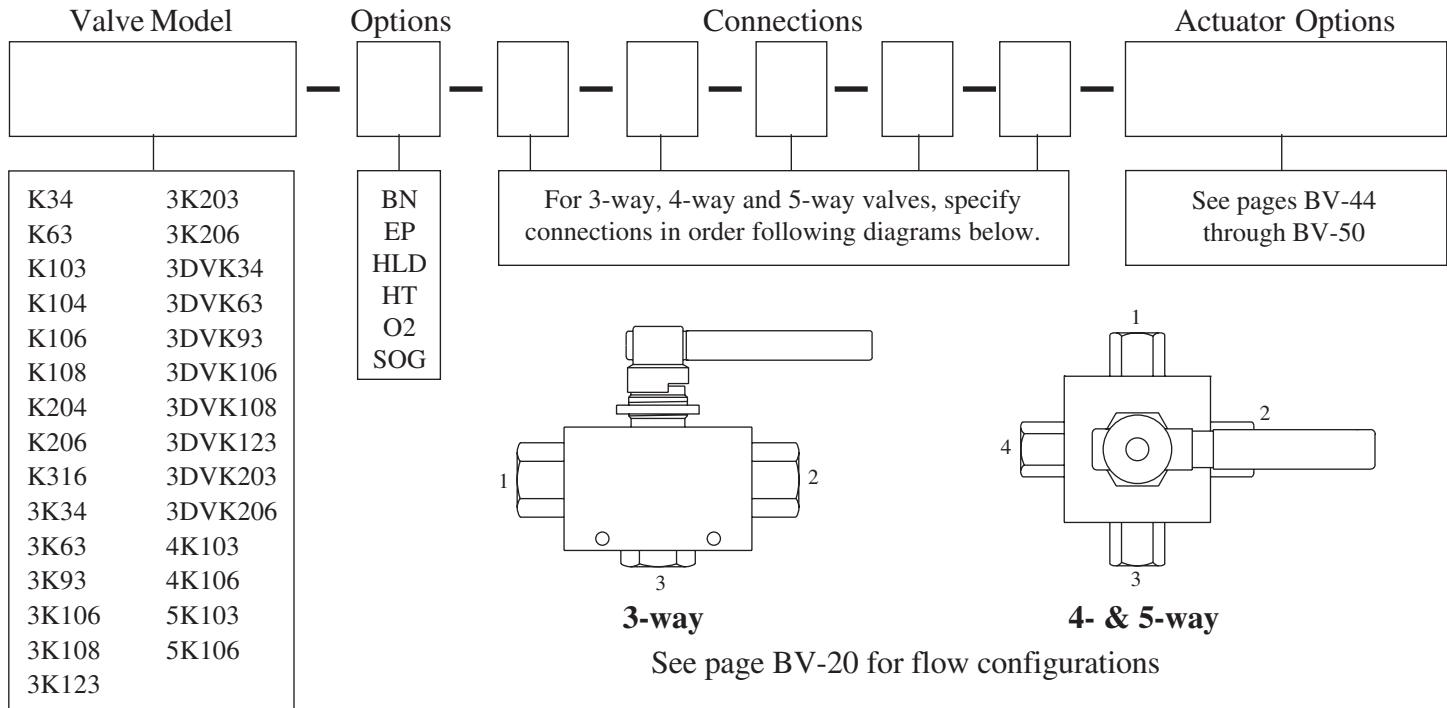

Examples:

A 2-way valve with 0.250" port, 10,000 PSI with 3/8" female NPT connections and Buna-N o-rings
K104-BN-21-21

A 2-way valve with 0.375" port, 20,000 PSI with 1/2" female NPT and 9/16" male M/P coned-and-threaded connections and double-acting pneumatic actuator
K206-22-11-RA05DA

A 3-way valve for switching service with 0.500" port, 10,000 PSI with 1/2" female NPT side connections and 3/4" male NPT bottom connection for high-temperature service
3K108-HT-22-22-55B

A 4-way valve with 0.187" port, 10,000 PSI with (2) 1/4" FNPT connections and (2) 3/8" FNPT connections
4K103-20-20-21-21

Options:

- BN** Buna-N o-rings
- EP** EPR o-rings
- HLD** Handle locking device (prevents unauthorized opening/closing of valve)
- HT** High-temperature o-rings for continuous service to 550°F (288°C)
- O2** Cleaned for oxygen service
- SOG** For Sour Gas service in accordance with NACE MR-01-75

BuTech ball valves may be manufactured from any machinable metal and fitted with special seal materials. Please consult factory for information.

All dimensions are for reference only and are subject to change.
 Dimensions in parentheses are millimeters (mm).



上海兆帕流体动力有限公司 / Shanghai MPA Fluid Power Co.,Ltd.
 Web: www.mpapower.com / E-mail: info@mpapower.com

BALL VALVE LOCATOR

	Model No.	Maximum Pressure*	Port	Cv	Page
2-way Valves for On-Off Service	K34	3,000 PSI 210 bar	0.250" (6.4)	1.40	BV-4
	K316	3,000 PSI 210 bar	1.000" (25.4)	36.00	BV-5
	K63	6,000 PSI 410 bar	0.187" (4.7)	0.75	BV-6
	K103	10,000 PSI 690 bar	0.187" (4.7)	0.75	BV-8
	K104	10,000 PSI 690 bar	0.250" (6.4)	1.40	BV-10
	K106	10,000 PSI 690 bar	0.375" (9.5)	3.40	BV-12
	K108	10,000 PSI 690 bar	0.500" (12.7)	10.00	BV-14
	K204	20,000 PSI 1380 bar	0.250" (6.4)	1.40	BV-16
	K206	20,000 PSI 1380 bar	0.375" (9.5)	3.40	BV-18
3-way Valves for Switching Service	3K34	3,000 PSI 210 bar	0.250" (6.4)	1.00	BV-21
	3K63	6,000 PSI 410 bar	0.187" (4.7)	0.56	BV-22
	3K93	10,000 PSI 690 bar	0.187" (4.7)	0.56	BV-24
	3K106	10,000 PSI 690 bar	0.375" (9.5)	2.40	BV-26
	3K108	10,000 PSI 690 bar	0.500" (12.7)	5.00	BV-28
	3K123	12,000 PSI 830 bar	0.187" (4.7)	0.56	BV-30
	3K203	20,000 PSI 1380 bar	0.187" (4.7)	0.56	BV-32
	3K206	20,000 PSI 1380 bar	0.375" (9.5)	2.40	BV-34
3-way Valves for Diverting Service	3DVK34	3,000 PSI 210 bar	0.250" (6.4)	1.00	BV-21
	3DVK63	6,000 PSI 410 bar	0.187" (4.7)	0.56	BV-22
	3DVK93	10,000 PSI 690 bar	0.187" (4.7)	0.56	BV-24
	3DVK106	10,000 PSI 690 bar	0.375" (9.5)	2.40	BV-26
	3DVK108	10,000 PSI 690 bar	0.500" (12.7)	5.00	BV-28
	3DVK123	12,000 PSI 830 bar	0.187" (4.7)	0.56	BV-30
	3DVK203	20,000 PSI 1380 bar	0.187" (4.7)	0.56	BV-32
	3DVK206	20,000 PSI 1380 bar	0.375" (9.5)	2.40	BV-34
4-way & 5-way Valves	4K103	10,000 PSI 690 bar	0.187" (4.7)	0.56	BV-36
	5K103	10,000 PSI 690 bar	0.187" (4.7)	0.56	BV-40
	4K106	10,000 PSI 690 bar	0.375" (9.5)	2.40	BV-38
	5K106	10,000 PSI 690 bar	0.375" (9.5)	2.40	BV-42

NOTE: Standard operating temperature range is -20 to 400° F (-28 to 204°C). For applications requiring higher temperatures, select the **-HT** option shown on page BV-2.

***CAUTION:** The maximum allowable working pressure (MAWP) of the valve shall not exceed the MAWP of the valve series or the selected connection, whichever is less.

All dimensions are for reference only and are subject to change.
Dimensions in parentheses are millimeters (mm).

上海兆帕流体动力有限公司 / Shanghai MPA Fluid Power Co.,Ltd.
Web: www.mpapower.com / E-mail: info@mpapower.com



3000 PSI (210 BAR) 2-WAY BALL VALVES

Model No. K34

Mounting:

Panel: 0.78" (19.8 mm) dia
0.37" (9.4 mm) max thickness

*MAWP: 3,000 PSI (210 bar)
Port: 0.250" (6.4 mm)
Cv: 1.40

Materials of Construction:

- 316 cold-worked stainless steel body and side adapters
- 316 cold-worked stem
- PEEK ball seals
- Glass-filled Teflon stem packings
- Viton O-rings

Ordering information and options on page BV-2

Repair Kit P/N RK-K34 contains ball, ball seals and seal retainers, o-rings, pins, stem, stem packings, and washers

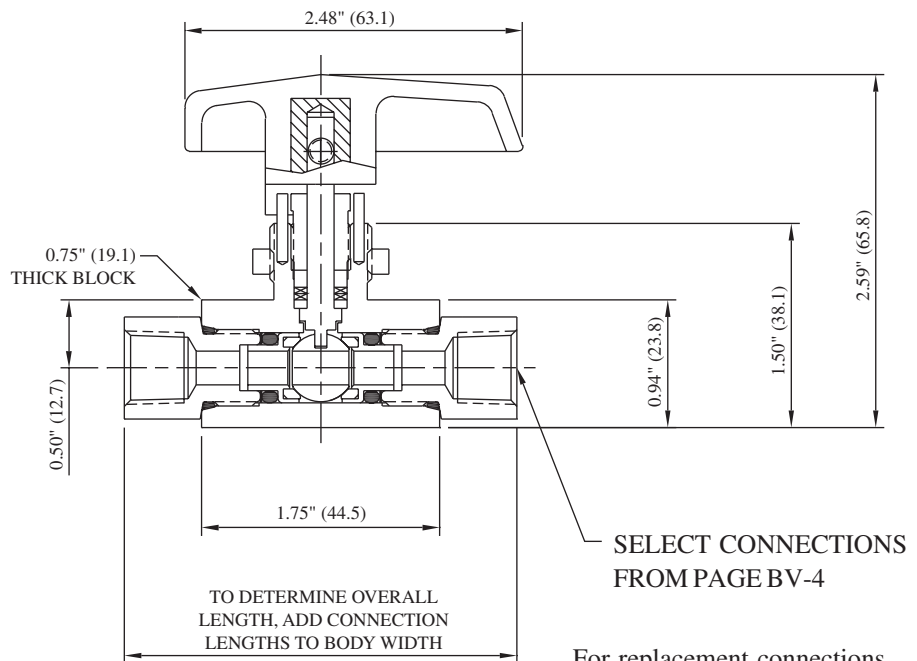

SELECT CONNECTIONS FROM PAGE BV-4
For replacement connections, use prefix number **40-** and suffix number. Ex: 40-20

FEMALE PIPE

Connection	Suffix	Hex	Length	Port	MAWP*
1/8" FNPT	19	0.75" (19.1)	0.58" (14.7)	0.250" (6.4)	15,000 PSI 1030 bar
1/4" FNPT	20	0.75" (19.1)	0.58" (14.7)	0.250" (6.4)	15,000 PSI 1030 bar
3/8" FNPT	21	1.00" (25.4)	0.75" (19.1)	0.250" (6.4)	15,000 PSI 1030 bar
1/2" FNPT	22	1.18" (30.0)	1.00" (25.4)	0.250" (6.4)	15,000 PSI 1030 bar

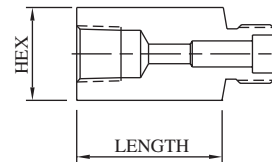

MALE PIPE

Connection	Suffix	Hex	Length	Port	MAWP*
1/8" MNPT	4	0.75" (19.1)	0.97" (24.6)	0.250" (6.4)	15,000 PSI 1030 bar
1/4" MNPT	5	0.75" (19.1)	1.19" (30.2)	0.250" (6.4)	15,000 PSI 1030 bar
3/8" MNPT	6	1.00" (25.4)	1.30" (33.0)	0.250" (6.4)	15,000 PSI 1030 bar
1/2" MNPT	7	1.00" (25.4)	1.55" (39.4)	0.250" (6.4)	15,000 PSI 1030 bar

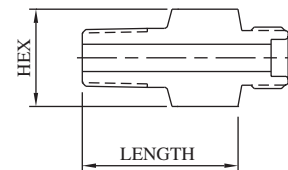

***CAUTION:** The maximum allowable working pressure (MAWP) of the valve shall not exceed the MAWP of the valve series or the selected connection, whichever is less.

All dimensions are for reference only and are subject to change.
Dimensions in parentheses are millimeters (mm).



上海兆帕流体动力有限公司 / Shanghai MPA Fluid Power Co.,Ltd.
Web: www.mpapower.com / E-mail: info@mpapower.com

3000 PSI (210 BAR) 2-WAY BALL VALVES

Mounting:

Side: 0.47" (11.9 mm) dia

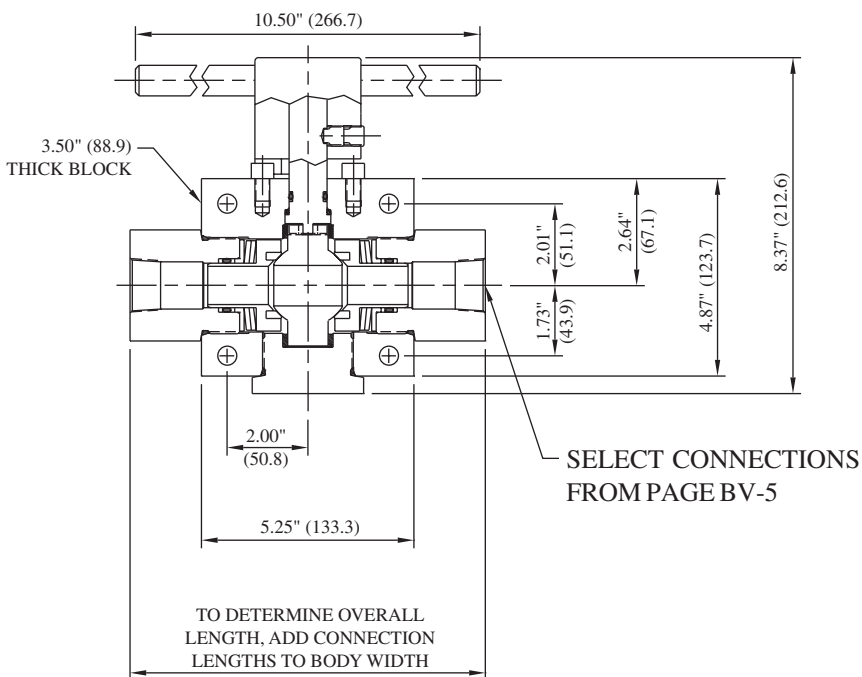

For replacement connections, use prefix number **160-** and suffix number. Ex: 160-20

Model No. K316

*MAWP: 3,000 PSI (210 bar)
Port: 1.000" (25.4 mm)
Cv: 36.00

Materials of Construction:

- 316 cold-worked stainless steel body and side adapters
- 17-4PH stem
- PEEK ball seals
- Viton O-rings
- Teflon back-ups

Ordering information and options on page BV-2

Repair Kit P/N RK-K316 contains stem, ball, ball seals and seal retainers, o-rings, spring washers, and bearing washers

FEMALE PIPE

Connection	Suffix	Hex	Length	Port	MAWP*
3/4" FNPT	41	2.75" (69.9)	1.05" (26.7)	0.922" (23.4)	10,000 PSI 690 bar
1" FNPT	45	2.75" (69.9)	1.22" (31.0)	1.102" (28.0)	10,000 PSI 690 bar
1-1/2" FNPT	46	2.75" (69.9)	1.63" (41.4)	1.102" (28.0)	5,000 PSI 340 bar

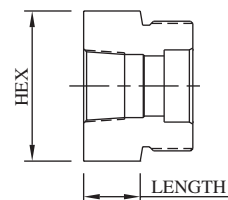

MALE PIPE

Connection	Suffix	Hex	Length	Port	MAWP*
3/4" MNPT	55	2.75" (69.9)	1.82" (46.2)	0.625" (15.9)	10,000 PSI 690 bar
1" MNPT	56	2.75" (69.9)	2.03" (51.6)	0.687" (17.4)	10,000 PSI 690 bar
1-1/2" MNPT	121	2.75" (69.9)	1.96" (49.8)	1.102" (28.0)	5,000 PSI 340 bar

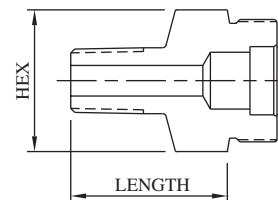

***CAUTION:** The maximum allowable working pressure (MAWP) of the valve shall not exceed the MAWP of the valve series or the selected connection, whichever is less.

All dimensions are for reference only and are subject to change.
Dimensions in parentheses are millimeters (mm).

上海兆帕流体动力有限公司 / Shanghai MPA Fluid Power Co., Ltd.
Web: www.mpapower.com / E-mail: info@mpapower.com



6000 PSI (410 BAR) 2-WAY BALL VALVES

Model No. K63

*MAWP: 6,000 PSI (410 bar)
 Port: 0.187" (4.7 mm)
 Cv: 0.75

Materials of Construction:

- 316 cold-worked stainless steel body and side adapters
- 316 cold-worked stem
- PEEK ball seals
- Glass-filled Teflon stem packings
- Viton O-rings

Ordering information and options on page BV-2

Repair Kit P/N RK-K63 contains ball, ball seals and seal retainers, o-rings, spring washers, stem, stem packings, and washers

Mounting:

Panel: 0.91" (23.0 mm) dia
 0.31" (7.8 mm) max thickness

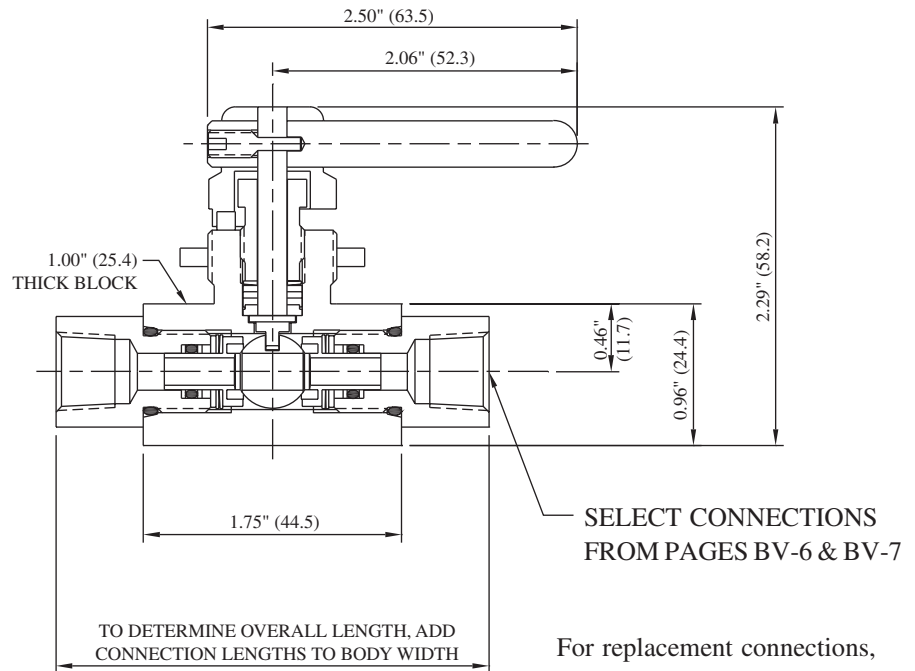

For replacement connections, use prefix number **3-** and suffix number. Ex: 3-20

FEMALE PIPE

Connection	Suffix	Hex	Length	Port	MAWP*
1/8" FNPT	19	0.75" (19.1)	0.60" (15.2)	0.250" (6.4)	15,000 PSI 1030 bar
1/4" FNPT	20	0.75" (19.1)	0.60" (15.2)	0.250" (6.4)	15,000 PSI 1030 bar
3/8" FNPT	21	1.00" (25.4)	1.01" (25.7)	0.250" (6.4)	15,000 PSI 1030 bar
1/2" FNPT	22	1.00" (25.4)	1.01" (25.7)	0.250" (6.4)	15,000 PSI 1030 bar

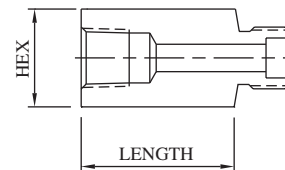

MALE PIPE

Connection	Suffix	Hex	Length	Port	MAWP*
1/8" MNPT	4	0.75" (19.1)	1.01" (25.7)	0.125" (3.2)	15,000 PSI 1030 bar
1/4" MNPT	5	0.75" (19.1)	1.01" (25.7)	0.250" (6.4)	15,000 PSI 1030 bar
3/8" MNPT	6	0.75" (19.1)	1.01" (25.7)	0.250" (6.4)	15,000 PSI 1030 bar
1/2" MNPT	7	1.00" (25.4)	1.26" (32.0)	0.250" (6.4)	15,000 PSI 1030 bar

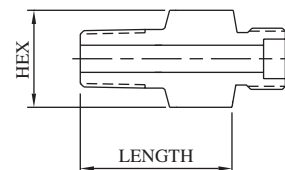

***CAUTION:** The maximum allowable working pressure (MAWP) of the valve shall not exceed the MAWP of the valve series or the selected connection, whichever is less.

All dimensions are for reference only and are subject to change.
 Dimensions in parentheses are millimeters (mm).



上海兆帕流体动力有限公司 / Shanghai MPA Fluid Power Co.,Ltd.
 Web: www.mpapower.com / E-mail: info@mpapower.com

6000 PSI (410 BAR) 2-WAY BALL VALVES

Model No. **K63**

FEMALE SINGLE-FERRULE TUBE

Connection	Suffix	Hex	Length	Port	MAWP*
1/8" L/P	12	0.75" (19.1)	0.78" (19.8)	0.093" (2.4)	15,000 PSI 1030 bar
1/4" SL/P	13	0.75" (19.1)	1.03" (26.2)	0.125" (3.2)	11,500 PSI 790 bar
3/8" SL/P	14	0.75" (19.1)	1.03" (26.2)	0.250" (6.4)	7,500 PSI 520 bar
1/2" L/P	15	1.00" (25.4)	1.03" (26.2)	0.250" (6.4)	5,500 PSI 380 bar

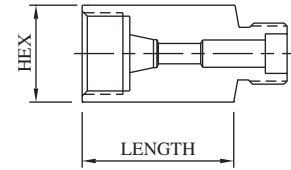

FEMALE M/P CONED AND THREADED TUBE

Connection	Suffix	Hex	Length	Port	MAWP*
1/4" M/P	16	0.75" (19.1)	0.74" (18.8)	0.109" (2.8)	20,000 PSI 1380 bar
3/8" M/P	17	0.75" (19.1)	1.01" (25.7)	0.203" (5.2)	20,000 PSI 1380 bar
9/16" M/P	18	1.00" (25.4)	1.26" (32.0)	0.250" (6.4)	20,000 PSI 1380 bar

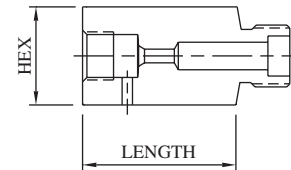

MALE M/P CONED AND THREADED TUBE

Connection	Suffix	Hex	Length	Port	MAWP*
1/4" M/P	8	0.75" (19.1)	1.88" (47.8)	0.109" (2.8)	20,000 PSI 1380 bar
3/8" M/P	10	0.75" (19.1)	2.00" (50.8)	0.203" (5.2)	20,000 PSI 1380 bar
9/16" M/P	11	1.00" (25.4)	2.31" (58.7)	0.250" (6.4)	20,000 PSI 1380 bar

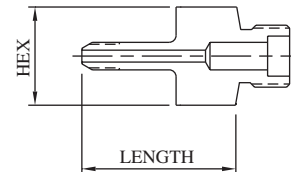

FEMALE H/P CONED AND THREADED TUBE

Connection	Suffix	Hex	Length	Port	MAWP*
1/4" H/P	23	0.75" (19.1)	1.01" (25.7)	0.093" (2.4)	20,000 PSI 1380 bar
3/8" H/P	24	1.00" (25.4)	1.17" (29.7)	0.125" (3.2)	20,000 PSI 1380 bar
9/16" H/P	25	1.37" (34.8)	1.25" (31.8)	0.187" (4.7)	20,000 PSI 1380 bar

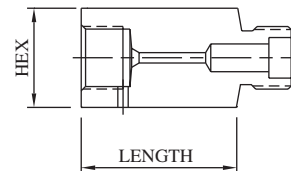

MALE H/P CONED AND THREADED TUBE

Connection	Suffix	Hex	Length	Port	MAWP*
1/4" H/P	9	0.75" (19.1)	1.94" (49.3)	0.083" (2.1)	20,000 PSI 1380 bar
3/8" H/P	30	0.75" (19.1)	2.25" (57.2)	0.125" (3.2)	20,000 PSI 1380 bar
9/16" H/P	42	0.75" (19.1)	2.82" (71.6)	0.187" (4.7)	20,000 PSI 1380 bar

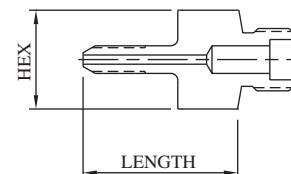

***CAUTION:** The maximum allowable working pressure (MAWP) of the valve shall not exceed the MAWP of the valve series or the selected connection, whichever is less.

All dimensions are for reference only and are subject to change.
Dimensions in parentheses are millimeters (mm).

上海兆帕流体动力有限公司 / Shanghai MPA Fluid Power Co., Ltd.
Web: www.mpapower.com / E-mail: info@mpapower.com



10,000 PSI (690 BAR) 2-WAY BALL VALVES

Model No. K103

*MAWP: 10,000 PSI (690 bar)
 Port: 0.187" (4.7 mm)
 Cv: 0.75

Materials of Construction:

- 316 cold-worked stainless steel body and side adapters
- 316 cold-worked stem
- PEEK ball seals
- Glass-filled Teflon stem packings
- Viton O-rings

Ordering information and options on page BV-2

Repair Kit P/N RK-K103 contains ball, ball seals and seal retainers, o-rings, spring washers, stem, stem packings, and washers

Mounting:

Panel: 0.91" (23.0 mm) dia
 0.31" (7.8 mm) max thickness

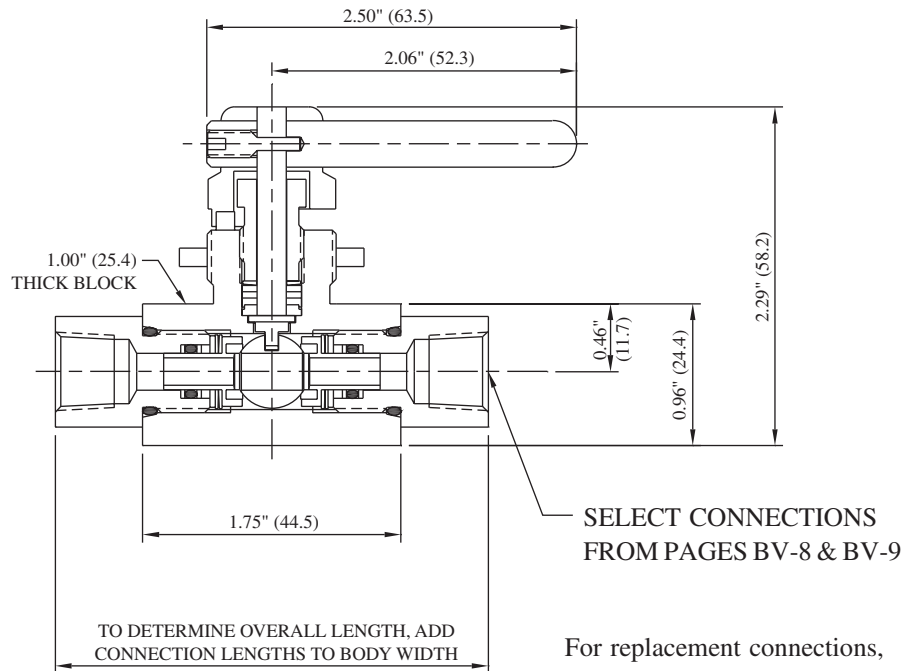

For replacement connections, use prefix number **3-** and suffix number. Ex: 3-20

FEMALE PIPE

Connection	Suffix	Hex	Length	Port	MAWP*
1/8" FNPT	19	0.75" (19.1)	0.60" (15.2)	0.250" (6.4)	15,000 PSI 1030 bar
1/4" FNPT	20	0.75" (19.1)	0.60" (15.2)	0.250" (6.4)	15,000 PSI 1030 bar
3/8" FNPT	21	1.00" (25.4)	1.01" (25.7)	0.250" (6.4)	15,000 PSI 1030 bar
1/2" FNPT	22	1.00" (25.4)	1.01" (25.7)	0.250" (6.4)	15,000 PSI 1030 bar

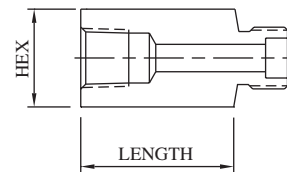

MALE PIPE

Connection	Suffix	Hex	Length	Port	MAWP*
1/8" MNPT	4	0.75" (19.1)	1.01" (25.7)	0.125" (3.2)	15,000 PSI 1030 bar
1/4" MNPT	5	0.75" (19.1)	1.01" (25.7)	0.250" (6.4)	15,000 PSI 1030 bar
3/8" MNPT	6	0.75" (19.1)	1.01" (25.7)	0.250" (6.4)	15,000 PSI 1030 bar
1/2" MNPT	7	1.00" (25.4)	1.26" (32.0)	0.250" (6.4)	15,000 PSI 1030 bar

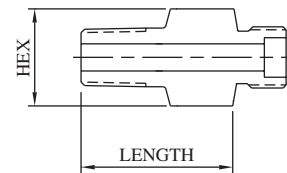

***CAUTION:** The maximum allowable working pressure (MAWP) of the valve shall not exceed the MAWP of the valve series or the selected connection, whichever is less.

All dimensions are for reference only and are subject to change.
 Dimensions in parentheses are millimeters (mm).



上海兆帕流体动力有限公司 / Shanghai MPA Fluid Power Co.,Ltd.
 Web: www.mpapower.com / E-mail: info@mpapower.com

10,000 PSI (690 BAR) 2-WAY BALL VALVES

Model No. **K103**

FEMALE SINGLE-FERRULE TUBE

Connection	Suffix	Hex	Length	Port	MAWP*
1/8" L/P	12	0.75" (19.1)	0.78" (19.8)	0.093" (2.4)	15,000 PSI 1030 bar
1/4" SL/P	13	0.75" (19.1)	1.03" (26.2)	0.125" (3.2)	11,500 PSI 790 bar
3/8" SL/P	14	0.75" (19.1)	1.03" (26.2)	0.250" (6.4)	7,500 PSI 520 bar
1/2" L/P	15	1.00" (25.4)	1.03" (26.2)	0.250" (6.4)	5,500 PSI 380 bar

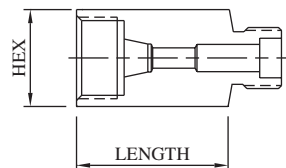

FEMALE M/P CONED AND THREADED TUBE

Connection	Suffix	Hex	Length	Port	MAWP*
1/4" M/P	16	0.75" (19.1)	0.74" (18.8)	0.109" (2.8)	20,000 PSI 1380 bar
3/8" M/P	17	0.75" (19.1)	1.01" (25.7)	0.203" (5.2)	20,000 PSI 1380 bar
9/16" M/P	18	1.00" (25.4)	1.26" (32.0)	0.250" (6.4)	20,000 PSI 1380 bar

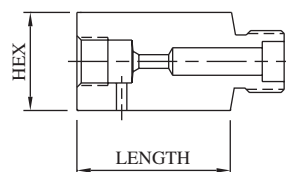

MALE M/P CONED AND THREADED TUBE

Connection	Suffix	Hex	Length	Port	MAWP*
1/4" M/P	8	0.75" (19.1)	1.88" (47.8)	0.109" (2.8)	20,000 PSI 1380 bar
3/8" M/P	10	0.75" (19.1)	2.00" (50.8)	0.203" (5.2)	20,000 PSI 1380 bar
9/16" M/P	11	1.00" (25.4)	2.31" (58.7)	0.250" (6.4)	20,000 PSI 1380 bar

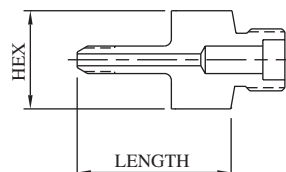

FEMALE H/P CONED AND THREADED TUBE

Connection	Suffix	Hex	Length	Port	MAWP*
1/4" H/P	23	0.75" (19.1)	1.01" (25.7)	0.093" (2.4)	20,000 PSI 1380 bar
3/8" H/P	24	1.00" (25.4)	1.17" (29.7)	0.125" (3.2)	20,000 PSI 1380 bar
9/16" H/P	25	1.37" (34.8)	1.25" (31.8)	0.187" (4.7)	20,000 PSI 1380 bar

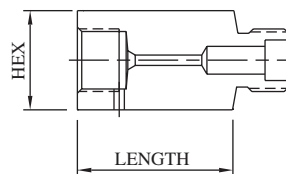

MALE H/P CONED AND THREADED TUBE

Connection	Suffix	Hex	Length	Port	MAWP*
1/4" H/P	9	0.75" (19.1)	1.94" (49.3)	0.083" (2.1)	20,000 PSI 1380 bar
3/8" H/P	30	0.75" (19.1)	2.25" (57.2)	0.125" (3.2)	20,000 PSI 1380 bar
9/16" H/P	42	0.75" (19.1)	2.82" (71.6)	0.187" (4.7)	20,000 PSI 1380 bar

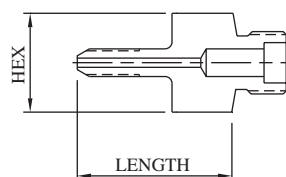

***CAUTION:** The maximum allowable working pressure (MAWP) of the valve shall not exceed the MAWP of the valve series or the selected connection, whichever is less.

All dimensions are for reference only and are subject to change.
Dimensions in parentheses are millimeters (mm).

上海兆帕流体动力有限公司 / Shanghai MPA Fluid Power Co.,Ltd.
Web: www.mpapower.com / E-mail: info@mpapower.com



10,000 PSI (690 BAR) 2-WAY BALL VALVES

Model No. K104

*MAWP: 10,000 PSI (690 bar)
 Port: 0.250" (6.4 mm)
 Cv: 1.40

Materials of Construction:

- 316 cold-worked stainless steel body and side adapters
- 17-4PH stem
- PEEK ball seals
- Glass-filled Teflon stem packings
- Viton O-rings

Ordering information and options on page BV-2

Repair Kit P/N RK-K104 contains ball, ball seals and seal retainers, o-rings, stem, stem packings, and washers

Mounting:

Panel: 1.06" (26.9 mm) dia
 0.43" (11.0 mm) max thickness
 Top: 1/4"-20 UNC
 Side: 0.28" (7.1 mm) dia

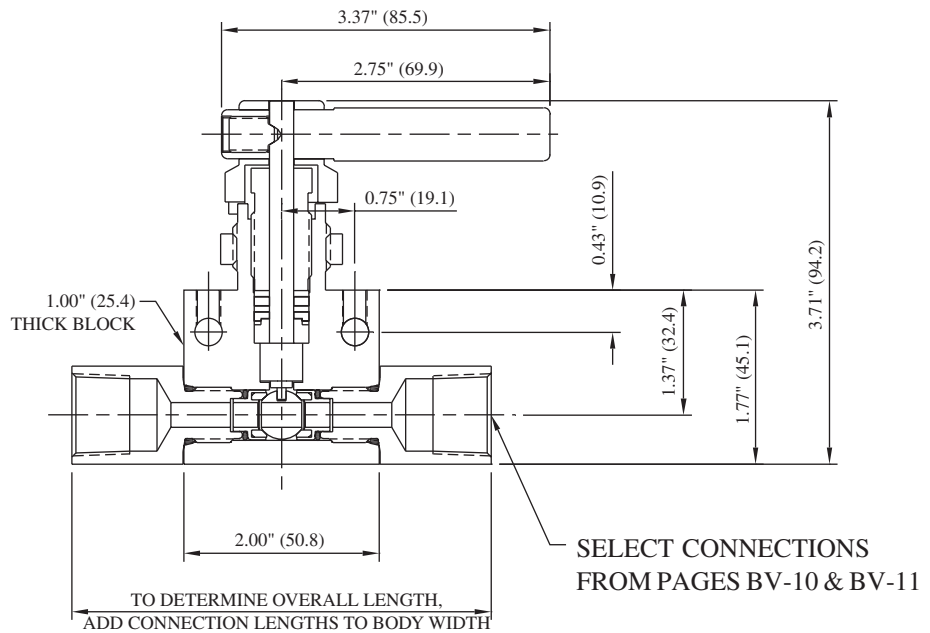

For replacement connections, use prefix number **4-** and suffix number. Ex: 4-20

FEMALE PIPE

Connection	Suffix	Hex	Length	Port	MAWP*
1/8" FNPT	19	0.75" (19.1)	1.03" (26.2)	0.250" (6.4)	15,000 PSI 1030 bar
1/4" FNPT	20	0.75" (19.1)	1.03" (26.2)	0.250" (6.4)	15,000 PSI 1030 bar
3/8" FNPT	21	1.38" (35.1)	1.03" (26.2)	0.250" (6.4)	15,000 PSI 1030 bar
1/2" FNPT	22	1.38" (35.1)	1.16" (29.5)	0.250" (6.4)	15,000 PSI 1030 bar

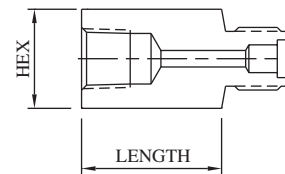

MALE PIPE

Connection	Suffix	Hex	Length	Port	MAWP*
1/8" MNPT	4	0.75" (19.1)	1.03" (26.2)	0.125" (3.2)	15,000 PSI 1030 bar
1/4" MNPT	5	0.75" (19.1)	1.03" (26.2)	0.250" (6.4)	15,000 PSI 1030 bar
3/8" MNPT	6	0.75" (19.1)	1.03" (26.2)	0.250" (6.4)	15,000 PSI 1030 bar
1/2" MNPT	7	1.00" (25.4)	1.29" (32.8)	0.250" (6.4)	15,000 PSI 1030 bar

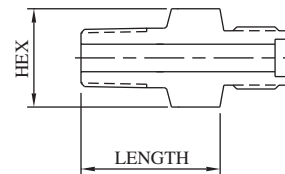

***CAUTION:** The maximum allowable working pressure (MAWP) of the valve shall not exceed the MAWP of the valve series or the selected connection, whichever is less.

All dimensions are for reference only and are subject to change.
 Dimensions in parentheses are millimeters (mm).



上海兆帕流体动力有限公司 / Shanghai MPA Fluid Power Co.,Ltd.
 Web: www.mpapower.com / E-mail: info@mpapower.com

10,000 PSI (690 BAR) 2-WAY BALL VALVES

Model No. **K104**

FEMALE SINGLE-FERRULE TUBE

Connection	Suffix	Hex	Length	Port	MAWP*
1/8" L/P	12	0.75" (19.1)	0.78" (19.8)	0.093" (2.4)	15,000 PSI 1030 bar
1/4" SL/P	13	0.75" (19.1)	1.03" (26.2)	0.125" (3.2)	11,500 PSI 790 bar
3/8" SL/P	14	0.75" (19.1)	1.03" (26.2)	0.250" (6.4)	7,500 PSI 520 bar
1/2" L/P	15	1.00" (25.4)	1.03" (26.2)	0.250" (6.4)	5,500 PSI 380 bar

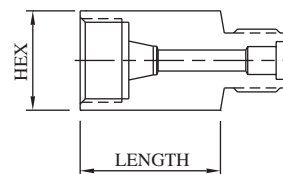

FEMALE M/P CONED AND THREADED TUBE

Connection	Suffix	Hex	Length	Port	MAWP*
1/4" M/P	16	0.75" (19.1)	1.03" (26.2)	0.109" (2.8)	20,000 PSI 1380 bar
3/8" M/P	17	0.75" (19.1)	1.03" (26.2)	0.203" (5.2)	20,000 PSI 1380 bar
9/16" M/P	18	1.00" (25.4)	1.29" (32.8)	0.250" (6.4)	20,000 PSI 1380 bar

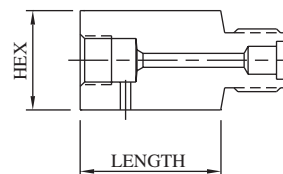

MALE M/P CONED AND THREADED TUBE

Connection	Suffix	Hex	Length	Port	MAWP*
1/4" M/P	8	0.75" (19.1)	1.91" (48.5)	0.109" (2.8)	20,000 PSI 1380 bar
3/8" M/P	10	0.75" (19.1)	1.91" (48.5)	0.203" (5.2)	20,000 PSI 1380 bar
9/16" M/P	11	0.75" (19.1)	2.12" (53.8)	0.312" (7.9)	20,000 PSI 1380 bar

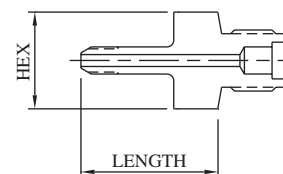

FEMALE H/P CONED AND THREADED TUBE

Connection	Suffix	Hex	Length	Port	MAWP*
1/4" H/P	23	0.75" (19.1)	1.03" (26.2)	0.093" (2.4)	20,000 PSI 1380 bar
3/8" H/P	24	1.00" (25.4)	1.03" (26.2)	0.125" (3.2)	20,000 PSI 1380 bar
9/16" H/P	25	1.38" (34.9)	1.16" (29.5)	0.187" (4.7)	20,000 PSI 1380 bar

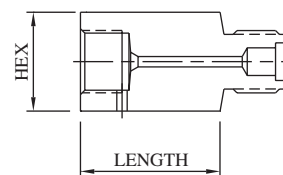

MALE H/P CONED AND THREADED TUBE

Connection	Suffix	Hex	Length	Port	MAWP*
1/4" H/P	9	0.75" (19.1)	1.91" (48.5)	0.093" (2.4)	20,000 PSI 1380 bar
3/8" H/P	30	0.75" (19.1)	2.12" (53.8)	0.125" (3.2)	20,000 PSI 1380 bar
9/16" H/P	42	0.75" (19.1)	2.86" (72.6)	0.187" (4.7)	20,000 PSI 1380 bar

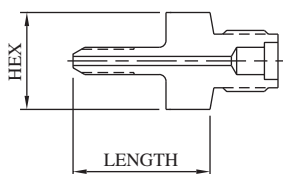

***CAUTION:** The maximum allowable working pressure (MAWP) of the valve shall not exceed the MAWP of the valve series or the selected connection, whichever is less.

All dimensions are for reference only and are subject to change.
Dimensions in parentheses are millimeters (mm).

上海兆帕流体动力有限公司 / Shanghai MPA Fluid Power Co.,Ltd.
Web: www.mpapower.com / E-mail: info@mpapower.com



10,000 PSI (690 BAR) 2-WAY BALL VALVES

Model No. K106

*MAWP: 10,000 PSI (690 bar)
 Port: 0.375" (9.5 mm)
 Cv: 3.40

Materials of Construction:

- 316 cold-worked stainless steel body and side adapters
- 17-4PH stem
- PEEK ball seals
- Glass-filled Teflon stem packings
- Viton O-rings

Ordering information and options on page BV-2

Repair Kit P/N RK-K106 contains ball, ball seals and seal retainers, o-rings, stem, stem packings, and washers

Mounting:

Panel: 1.06" (26.9 mm) dia
 0.43" (11.0 mm) max thickness
 Top: 1/4"-20 UNC
 Side: 0.28" (7.1 mm) dia

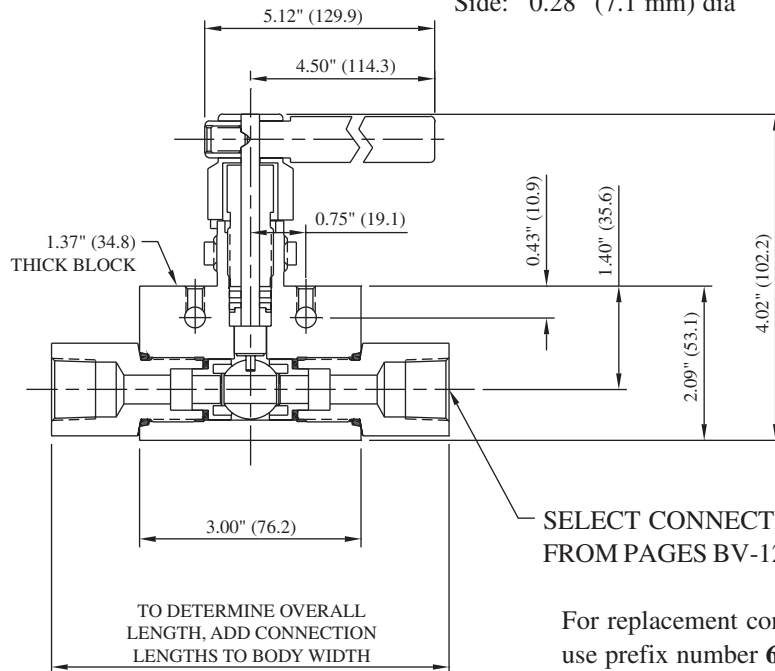

SELECT CONNECTIONS FROM PAGES BV-12 & BV-13

For replacement connections, use prefix number **6-** and suffix number. Ex: 6-20

FEMALE PIPE

Connection	Suffix	Hex	Length	Port	MAWP*
1/8" FNPT	19	1.00" (25.4)	0.69" (17.4)	0.339" (8.6)	15,000 PSI 1030 bar
1/4" FNPT	20	1.38" (34.9)	1.08" (27.4)	0.375" (9.5)	15,000 PSI 1030 bar
3/8" FNPT	21	1.38" (34.9)	1.02" (25.9)	0.375" (9.5)	15,000 PSI 1030 bar
1/2" FNPT	22	1.38" (34.9)	1.21" (30.7)	0.375" (9.5)	15,000 PSI 1030 bar
3/4" FNPT	41	1.38" (34.9)	1.33" (33.8)	0.375" (9.5)	10,000 PSI 690 bar
1" FNPT	45	1.75" (44.5)	1.62" (41.1)	0.375" (9.5)	10,000 PSI 690 bar

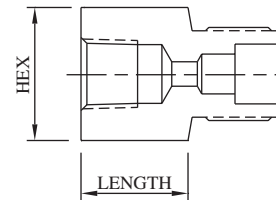

MALE PIPE

Connection	Suffix	Hex	Length	Port	MAWP*
1/8" MNPT	4	1.00" (25.4)	1.12" (28.4)	0.188" (4.8)	15,000 PSI 1030 bar
1/4" MNPT	5	1.38" (35.1)	1.41" (35.8)	0.258" (6.6)	15,000 PSI 1030 bar
3/8" MNPT	6	1.38" (34.9)	1.28" (32.5)	0.375" (9.5)	15,000 PSI 1030 bar
1/2" MNPT	7	1.38" (34.9)	1.33" (33.8)	0.375" (9.5)	15,000 PSI 1030 bar
3/4" MNPT	55	1.38" (35.1)	1.60" (40.6)	0.375" (9.5)	10,000 PSI 690 bar
1" MNPT	56	1.50" (38.1)	1.91" (48.5)	0.375" (9.5)	10,000 PSI 690 bar

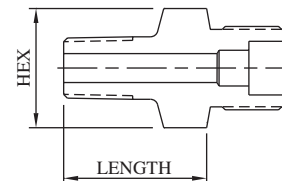

***CAUTION:** The maximum allowable working pressure (MAWP) of the valve shall not exceed the MAWP of the valve series or the selected connection, whichever is less.

All dimensions are for reference only and are subject to change.
 Dimensions in parentheses are millimeters (mm).



上海兆帕流体动力有限公司 / Shanghai MPA Fluid Power Co.,Ltd.
 Web: www.mpapower.com / E-mail: info@mpapower.com

10,000 PSI (690 BAR) 2-WAY BALL VALVES

Model No. **K106**

FEMALE SINGLE-FERRULE TUBE

Connection	Suffix	Hex	Length	Port	MAWP*
1/4" SL/P	13	1.38" (34.9)	0.66" (16.8)	0.257" (6.5)	11,500 PSI 790 bar
3/8" SL/P	14	1.38" (34.9)	1.00" (25.4)	0.312" (7.9)	7,500 PSI 520 bar
1/2" L/P	15	1.38" (34.9)	1.08" (27.4)	0.375" (9.5)	5,500 PSI 380 bar

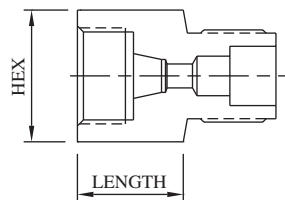

FEMALE M/P CONED AND THREADED TUBE

Connection	Suffix	Hex	Length	Port	MAWP
1/4" M/P	16	1.38" (35.1)	0.77" (19.6)	0.109" (2.8)	20,000 PSI 1380 bar
3/8" M/P	17	1.38" (35.1)	1.08" (27.4)	0.203" (5.2)	20,000 PSI 1380 bar
9/16" M/P	18	1.38" (35.1)	1.33" (33.8)	0.312" (7.9)	20,000 PSI 1380 bar
3/4" M/P	32	1.38" (35.1)	1.53" (38.9)	0.375" (9.5)	20,000 PSI 1380 bar
1" M/P	43	1.75" (44.5)	1.91" (48.5)	0.375" (9.5)	20,000 PSI 1380 bar

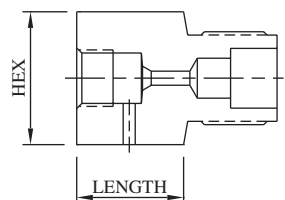

MALE M/P CONED AND THREADED TUBE

Connection	Suffix	Hex	Length	Port	MAWP*
1/4" M/P	8	1.00" (25.4)	1.89" (48.0)	0.109" (2.8)	20,000 PSI 1380 bar
3/8" M/P	10	1.38" (34.9)	1.90" (48.3)	0.203" (5.2)	20,000 PSI 1380 bar
9/16" M/P	11	1.38" (34.9)	2.13" (54.1)	0.312" (7.9)	20,000 PSI 1380 bar
3/4" M/P	37	1.38" (34.9)	5.08" (129.0)	0.437" (11.1)	20,000 PSI 1380 bar
1" M/P	49	1.38" (35.1)	3.21" (81.5)	0.437" (11.1)	20,000 PSI 1380 bar

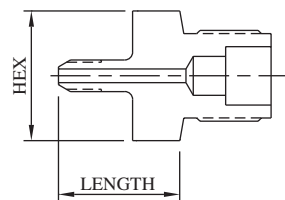

FEMALE H/P CONED AND THREADED TUBE

Connection	Suffix	Hex	Length	Port	MAWP*
1/4" H/P	23	1.38" (34.9)	1.02" (25.9)	0.083" (2.1)	20,000 PSI 1380 bar
3/8" H/P	24	1.38" (34.9)	1.04" (26.4)	0.125" (3.2)	20,000 PSI 1380 bar
9/16" H/P	25	1.38" (34.9)	1.13" (28.7)	0.187" (4.7)	20,000 PSI 1380 bar

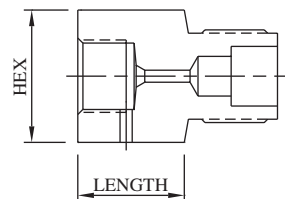

MALE H/P CONED AND THREADED TUBE

Connection	Suffix	Hex	Length	Port	MAWP*
1/4" H/P	9	1.00" (25.4)	1.98" (50.3)	0.083" (2.1)	20,000 PSI 1380 bar
3/8" H/P	30	1.00" (25.4)	2.38" (60.5)	0.125" (3.2)	20,000 PSI 1380 bar
9/16" H/P	42	1.00" (25.4)	2.85" (72.4)	0.188" (4.8)	20,000 PSI 1380 bar

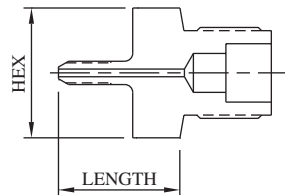

***CAUTION:** The maximum allowable working pressure (MAWP) of the valve shall not exceed the MAWP of the valve series or the selected connection, whichever is less.

All dimensions are for reference only and are subject to change.
Dimensions in parentheses are millimeters (mm).

上海兆帕流体动力有限公司 / Shanghai MPA Fluid Power Co.,Ltd.
Web: www.mpapower.com / E-mail: info@mpapower.com



10,000 PSI (690 BAR) 2-WAY BALL VALVES

Model No. K108

*MAWP: 10,000 PSI (690 bar)
 Port: 0.500" (12.7 mm)
 Cv: 10.00

Materials of Construction:

- 316 cold-worked stainless steel body and side adapters
- 17-4PH stem
- PEEK ball seals
- Glass-filled Teflon stem packings
- Viton O-rings

Ordering information and options on page BV-2

Repair Kit P/N RK-K108 contains ball, ball seals and seal retainers, o-rings, stem, stem packings, and washers

Mounting:

Side: 0.28" (7.1 mm) dia

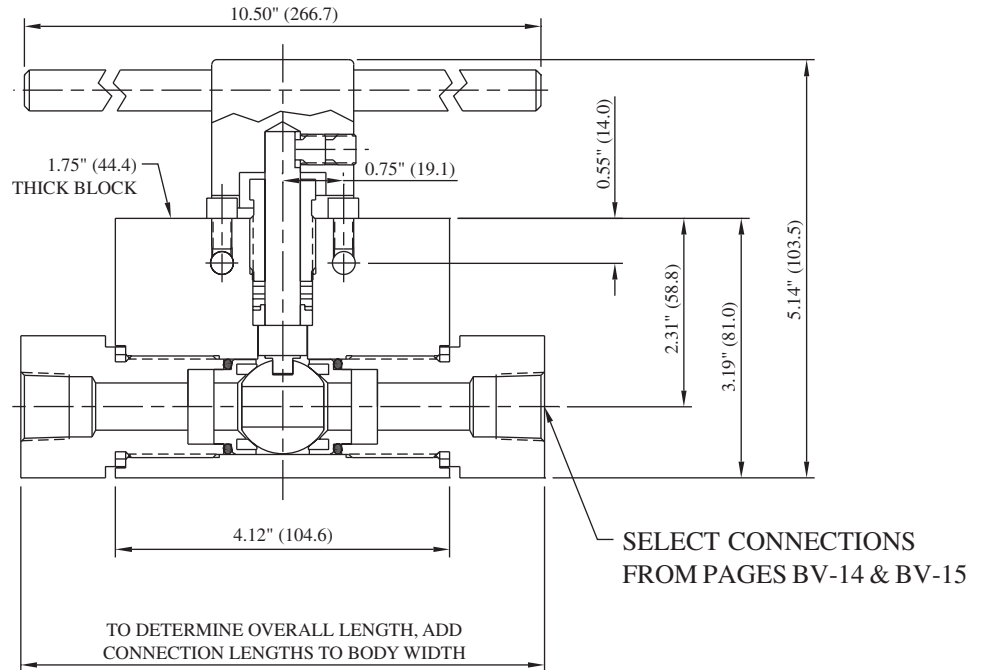

For replacement connections, use prefix number **8-** and suffix number. Ex: 8-22

FEMALE PIPE

Connection	Suffix	Hex	Length	Port	MAWP*
3/8" FNPT	21	1.75" (44.5)	1.00" (25.4)	0.578" (14.7)	15,000 PSI 1030 bar
1/2" FNPT	22	1.75" (44.5)	1.17" (29.7)	0.580" (14.7)	15,000 PSI 1030 bar
3/4" FNPT	41	1.75" (44.5)	1.33" (33.8)	0.580" (14.7)	10,000 PSI 690 bar
1" FNPT	45	1.75" (44.5)	1.54" (39.1)	0.580" (14.7)	10,000 PSI 690 bar
1-1/2" FNPT	46	2.50" (63.5)	1.92" (48.8)	0.580" (14.7)	5,000 PSI 340 bar

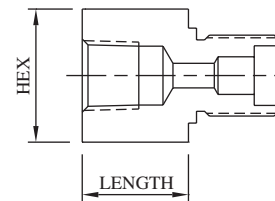

MALE PIPE

Connection	Suffix	Hex	Length	Port	MAWP*
3/8" MNPT	6	1.75" (44.5)	1.57" (39.9)	0.375" (9.5)	15,000 PSI 1030 bar
1/2" MNPT	7	1.75" (44.5)	1.80" (45.7)	0.500" (12.7)	15,000 PSI 1030 bar
3/4" MNPT	55	1.75" (44.5)	1.75" (44.5)	0.580" (14.7)	10,000 PSI 690 bar
1" MNPT	56	1.75" (44.5)	1.37" (34.8)	0.580" (14.7)	10,000 PSI 690 bar
1-1/2" MNPT	121	2.13" (54.0)	1.92" (48.8)	0.580" (14.7)	5,000 PSI 340 bar

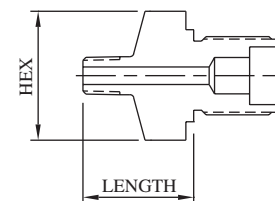

***CAUTION:** The maximum allowable working pressure (MAWP) of the valve shall not exceed the MAWP of the valve series or the selected connection, whichever is less.

All dimensions are for reference only and are subject to change.
 Dimensions in parentheses are millimeters (mm).



上海兆帕流体动力有限公司 / Shanghai MPA Fluid Power Co.,Ltd.
 Web: www.mpapower.com / E-mail: info@mpapower.com

10,000 PSI (690 BAR) 2-WAY BALL VALVES

Model No. **K108**

FEMALE COMPRESSION TUBE CONNECTIONS

Connection	Suffix	Hex	Length	Port	MAWP*
3/8" SL/P	14	1.75" (44.5)	1.00" (25.4)	0.312" (7.9)	7,500 PSI 520 bar
1/2" L/P	15	1.75" (44.5)	1.00" (25.4)	0.438" (11.1)	5,500 PSI 380 bar

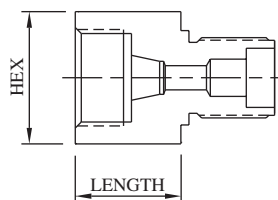

FEMALE M/P CONED AND THREADED TUBE

Connection	Suffix	Hex	Length	Port	MAWP*
3/8" M/P	17	1.75" (44.5)	0.87" (22.1)	0.203" (5.2)	20,000 PSI 1380 bar
9/16" M/P	18	1.75" (44.5)	1.67" (42.4)	0.312" (7.9)	20,000 PSI 1380 bar
3/4" M/P	32	1.75" (44.5)	1.18" (30.0)	0.580" (14.7)	20,000 PSI 1380 bar
1" M/P	43	1.75" (44.5)	1.67" (42.4)	0.580" (14.7)	20,000 PSI 1380 bar

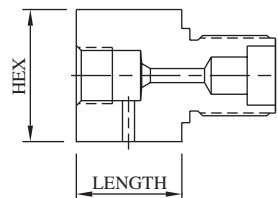

MALE M/P CONED AND THREADED TUBE

Connection	Suffix	Hex	Length	Port	MAWP*
3/8" M/P	10	1.75" (44.5)	2.33" (59.2)	0.203" (5.2)	20,000 PSI 1380 bar
9/16" M/P	11	1.75" (44.5)	2.71" (68.8)	0.312" (7.9)	20,000 PSI 1380 bar
3/4" M/P	37	1.75" (44.5)	2.74" (69.6)	0.438" (11.1)	20,000 PSI 1380 bar
1" M/P	49	1.75" (44.5)	2.88" (73.2)	0.562" (14.3)	20,000 PSI 1380 bar

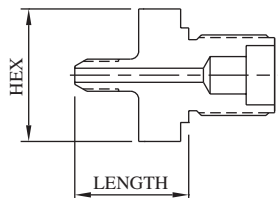

FEMALE H/P CONED AND THREADED TUBE

Connection	Suffix	Hex	Length	Port	MAWP*
1/4" H/P	23	1.75" (44.5)	0.63" (16.0)	0.093" (2.4)	20,000 PSI 1380 bar
3/8" H/P	24	1.75" (44.5)	1.00" (25.4)	0.125" (3.2)	20,000 PSI 1380 bar
9/16" H/P	25	1.75" (44.5)	1.06" (26.9)	0.188" (4.8)	20,000 PSI 1380 bar

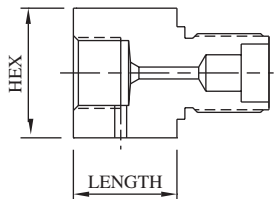

MALE H/P CONED AND THREADED TUBE

Connection	Suffix	Hex	Length	Port	MAWP*
1/4" H/P	9	1.75" (44.5)	2.22" (56.4)	0.083" (2.1)	20,000 PSI 1380 bar
3/8" H/P	30	1.75" (44.5)	2.45" (62.2)	0.125" (3.2)	20,000 PSI 1380 bar
9/16" H/P	42	1.75" (44.5)	2.96" (75.2)	0.188" (4.8)	20,000 PSI 1380 bar

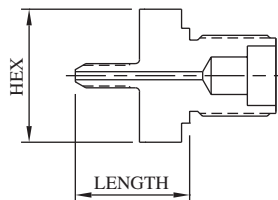

***CAUTION:** The maximum allowable working pressure (MAWP) of the valve shall not exceed the MAWP of the valve series or the selected connection, whichever is less.

All dimensions are for reference only and are subject to change.
Dimensions in parentheses are millimeters (mm).

上海兆帕流体动力有限公司 / Shanghai MPA Fluid Power Co.,Ltd.
Web: www.mpapower.com / E-mail: info@mpapower.com



20,000 PSI (1380 BAR) 2-WAY BALL VALVES

Model No. K204

*MAWP: 20,000 PSI (1380 bar)
 Port: 0.250" (6.4 mm)
 Cv: 1.40

Materials of Construction:

- 316 cold-worked stainless steel body and side adapters
- 17-4PH stem
- PEEK ball seals
- Glass-filled Teflon stem packings
- Viton O-rings

Ordering information and options on page BV-2

Repair Kit P/N RK-K204 contains ball, ball seals and seal retainers, o-rings, stem, stem packings, and washers

Mounting:

Panel: 1.06" (26.9 mm) dia
 0.43" (11.0 mm) max thickness
 Top: 1/4"-20 UNC
 Side: 0.28" (7.1 mm) dia

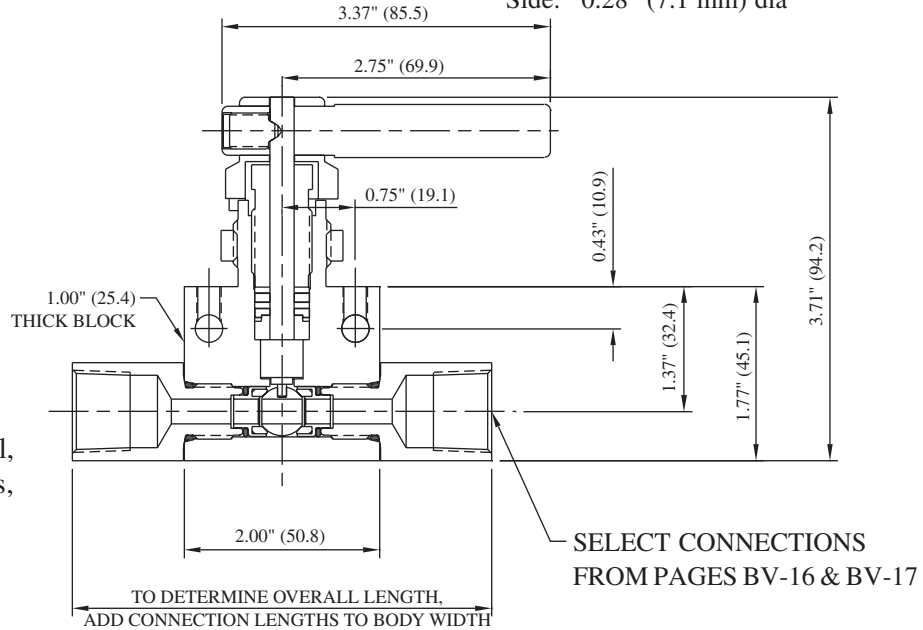

For replacement connections, use prefix number **4-** and suffix number. Ex: 4-20

FEMALE PIPE

Connection	Suffix	Hex	Length	Port	MAWP*
1/8" FNPT	19	0.75" (19.1)	1.03" (26.2)	0.250" (6.4)	15,000 PSI 1030 bar
1/4" FNPT	20	0.75" (19.1)	1.03" (26.2)	0.250" (6.4)	15,000 PSI 1030 bar
3/8" FNPT	21	1.38" (35.1)	1.03" (26.2)	0.250" (6.4)	15,000 PSI 1030 bar
1/2" FNPT	22	1.38" (35.1)	1.16" (29.5)	0.250" (6.4)	15,000 PSI 1030 bar

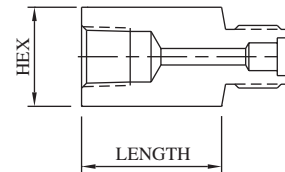

MALE PIPE

Connection	Suffix	Hex	Length	Port	MAWP*
1/8" MNPT	4	0.75" (19.1)	1.03" (26.2)	0.125" (3.2)	15,000 PSI 1030 bar
1/4" MNPT	5	0.75" (19.1)	1.03" (26.2)	0.250" (6.4)	15,000 PSI 1030 bar
3/8" MNPT	6	0.75" (19.1)	1.03" (26.2)	0.250" (6.4)	15,000 PSI 1030 bar
1/2" MNPT	7	1.00" (25.4)	1.29" (32.8)	0.250" (6.4)	15,000 PSI 1030 bar

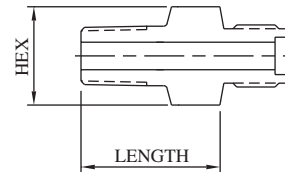

***CAUTION:** The maximum allowable working pressure (MAWP) of the valve shall not exceed the MAWP of the valve series or the selected connection, whichever is less.

All dimensions are for reference only and are subject to change.
 Dimensions in parentheses are millimeters (mm).



上海兆帕流体动力有限公司 / Shanghai MPA Fluid Power Co.,Ltd.
 Web: www.mpapower.com / E-mail: info@mpapower.com

20,000 PSI (1380 BAR) 2-WAY BALL VALVES

Model No. **K204**

FEMALE SINGLE-FERRULE TUBE

Connection	Suffix	Hex	Length	Port	MAWP*
1/8" L/P	12	0.75" (19.1)	0.78" (19.8)	0.093" (2.4)	15,000 PSI 1030 bar
1/4" SL/P	13	0.75" (19.1)	1.03" (26.2)	0.125" (3.2)	11,500 PSI 790 bar
3/8" SL/P	14	0.75" (19.1)	1.03" (26.2)	0.250" (6.4)	7,500 PSI 520 bar
1/2" L/P	15	1.00" (25.4)	1.03" (26.2)	0.250" (6.4)	5,500 PSI 380 bar

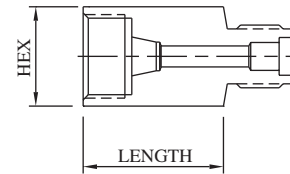

FEMALE M/P CONED AND THREADED TUBE

Connection	Suffix	Hex	Length	Port	MAWP*
1/4" M/P	16	0.75" (19.1)	1.03" (26.2)	0.109" (2.8)	20,000 PSI 1380 bar
3/8" M/P	17	0.75" (19.1)	1.03" (26.2)	0.203" (5.2)	20,000 PSI 1380 bar
9/16" M/P	18	1.00" (25.4)	1.29" (32.8)	0.250" (6.4)	20,000 PSI 1380 bar

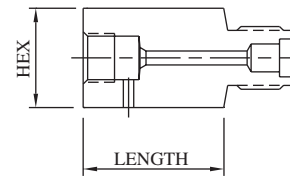

MALE M/P CONED AND THREADED TUBE

Connection	Suffix	Hex	Length	Port	MAWP*
1/4" M/P	8	0.75" (19.1)	1.91" (48.5)	0.109" (2.8)	20,000 PSI 1380 bar
3/8" M/P	10	0.75" (19.1)	1.91" (48.5)	0.203" (5.2)	20,000 PSI 1380 bar
9/16" M/P	11	0.75" (19.1)	2.12" (53.8)	0.312" (7.9)	20,000 PSI 1380 bar

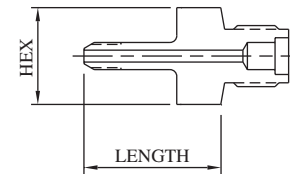

FEMALE H/P CONED AND THREADED TUBE

Connection	Suffix	Hex	Length	Port	MAWP*
1/4" H/P	23	0.75" (19.1)	1.03" (26.2)	0.093" (2.4)	20,000 PSI 1380 bar
3/8" H/P	24	1.00" (25.4)	1.03" (26.2)	0.125" (3.2)	20,000 PSI 1380 bar
9/16" H/P	25	1.38" (34.9)	1.16" (29.5)	0.187" (4.7)	20,000 PSI 1380 bar

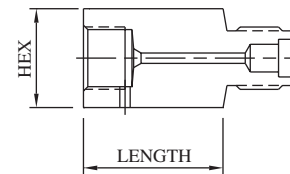

MALE H/P CONED AND THREADED TUBE

Connection	Suffix	Hex	Length	Port	MAWP*
1/4" H/P	9	0.75" (19.1)	1.91" (48.5)	0.093" (2.4)	20,000 PSI 1380 bar
3/8" H/P	30	0.75" (19.1)	2.12" (53.8)	0.125" (3.2)	20,000 PSI 1380 bar
9/16" H/P	42	0.75" (19.1)	2.86" (72.6)	0.187" (4.7)	20,000 PSI 1380 bar

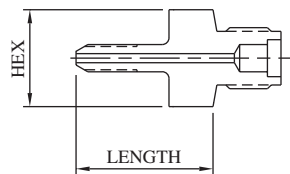

***CAUTION:** The maximum allowable working pressure (MAWP) of the valve shall not exceed the MAWP of the valve series or the selected connection, whichever is less.

All dimensions are for reference only and are subject to change.
Dimensions in parentheses are millimeters (mm).

上海兆帕流体动力有限公司 / Shanghai MPA Fluid Power Co.,Ltd.
Web: www.mpapower.com / E-mail: info@mpapower.com



20,000 PSI (1380 BAR) 2-WAY BALL VALVES

Model No. K206

*MAWP: 20,000 PSI (1380 bar)
 Port: 0.375" (9.5 mm)
 Cv: 3.40

Materials of Construction:

- 316 cold-worked stainless steel body and side adapters
- 17-4PH stem
- PEEK ball seals
- Glass-filled Teflon stem packings
- Viton O-rings

Ordering information and options on page BV-2

Repair Kit P/N RK-K206 contains ball, ball seals and seal retainers, o-rings, stem, stem packings, and washers

Mounting:

Panel: 1.06" (26.9 mm) dia
 0.43" (11.0 mm) max thickness
 Top: 1/4"-20 UNC
 Side: 0.28" (7.1 mm) dia

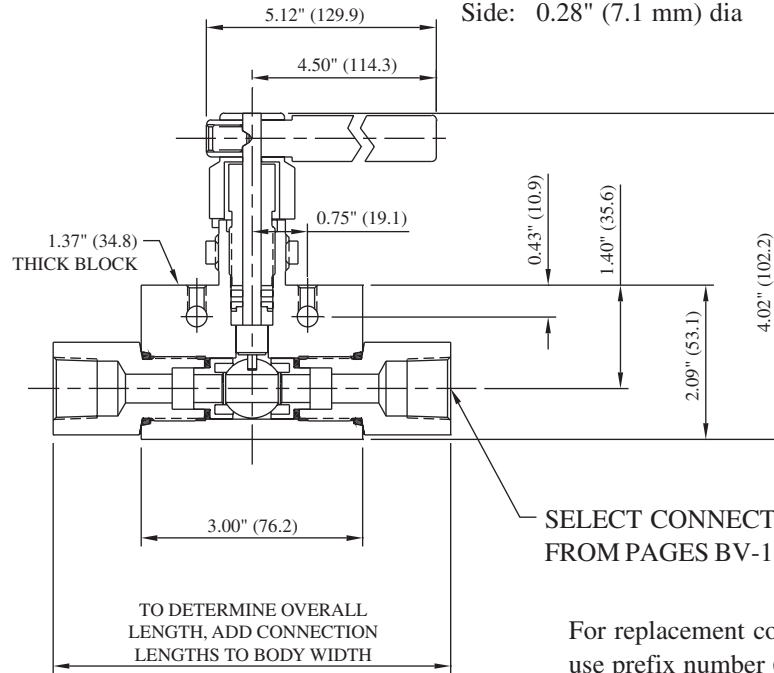

For replacement connections, use prefix number **6-** and suffix number. Ex: 6-20

FEMALE PIPE

Connection	Suffix	Hex	Length	Port	MAWP*
1/8" FNPT	19	1.00" (25.4)	0.69" (17.4)	0.339" (8.6)	15,000 PSI 1030 bar
1/4" FNPT	20	1.38" (34.9)	1.08" (27.4)	0.375" (9.5)	15,000 PSI 1030 bar
3/8" FNPT	21	1.38" (34.9)	1.02" (25.9)	0.375" (9.5)	15,000 PSI 1030 bar
1/2" FNPT	22	1.38" (34.9)	1.21" (30.7)	0.375" (9.5)	15,000 PSI 1030 bar
3/4" FNPT	41	1.38" (34.9)	1.33" (33.8)	0.375" (9.5)	10,000 PSI 690 bar
1" FNPT	45	1.75" (44.5)	1.62" (41.1)	0.375" (9.5)	10,000 PSI 690 bar

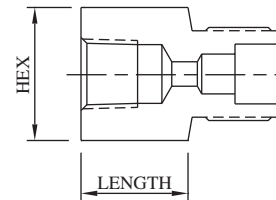

MALE PIPE

Connection	Suffix	Hex	Length	Port	MAWP*
1/8" MNPT	4	1.00" (25.4)	1.12" (28.4)	0.188" (4.8)	15,000 PSI 1030 bar
1/4" MNPT	5	1.38" (35.1)	1.41" (35.8)	0.258" (6.6)	15,000 PSI 1030 bar
3/8" MNPT	6	1.38" (34.9)	1.28" (32.5)	0.375" (9.5)	15,000 PSI 1030 bar
1/2" MNPT	7	1.38" (34.9)	1.33" (33.8)	0.375" (9.5)	15,000 PSI 1030 bar
3/4" MNPT	55	1.38" (35.1)	1.60" (40.6)	0.375" (9.5)	10,000 PSI 690 bar
1" MNPT	56	1.50" (38.1)	1.91" (48.5)	0.375" (9.5)	10,000 PSI 690 bar

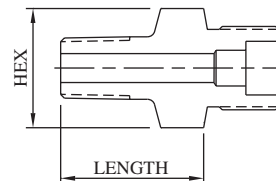

***CAUTION:** The maximum allowable working pressure (MAWP) of the valve shall not exceed the MAWP of the valve series or the selected connection, whichever is less.

All dimensions are for reference only and are subject to change.
 Dimensions in parentheses are millimeters (mm).



上海兆帕流体动力有限公司 / Shanghai MPA Fluid Power Co.,Ltd.
 Web: www.mpapower.com / E-mail: info@mpapower.com

20,000 PSI (1380 BAR) 2-WAY BALL VALVES

Model No. **K206**

FEMALE SINGLE-FERRULE TUBE

Connection	Suffix	Hex	Length	Port	MAWP*
1/4" SL/P	13	1.38" (34.9)	0.66" (16.8)	0.257" (6.5)	11,500 PSI 790 bar
3/8" SL/P	14	1.38" (34.9)	1.00" (25.4)	0.312" (7.9)	7,500 PSI 520 bar
1/2" L/P	15	1.38" (34.9)	1.08" (27.4)	0.375" (9.5)	5,500 PSI 380 bar

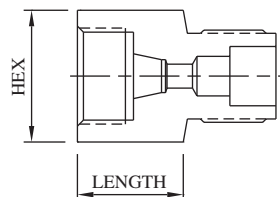

FEMALE M/P CONED AND THREADED TUBE

Connection	Suffix	Hex	Length	Port	MAWP
1/4" M/P	16	1.38" (35.1)	0.77" (19.6)	0.109" (2.8)	20,000 PSI 1380 bar
3/8" M/P	17	1.38" (35.1)	1.08" (27.4)	0.203" (5.2)	20,000 PSI 1380 bar
9/16" M/P	18	1.38" (35.1)	1.33" (33.8)	0.312" (7.9)	20,000 PSI 1380 bar
3/4" M/P	32	1.38" (35.1)	1.53" (38.9)	0.375" (9.5)	20,000 PSI 1380 bar
1" M/P	43	1.75" (44.5)	1.91" (48.5)	0.375" (9.5)	20,000 PSI 1380 bar

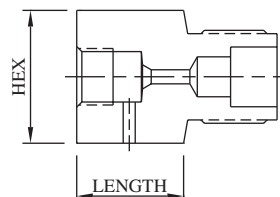

MALE M/P CONED AND THREADED TUBE

Connection	Suffix	Hex	Length	Port	MAWP*
1/4" M/P	8	1.00" (25.4)	1.89" (48.0)	0.109" (2.8)	20,000 PSI 1380 bar
3/8" M/P	10	1.38" (34.9)	1.90" (48.3)	0.203" (5.2)	20,000 PSI 1380 bar
9/16" M/P	11	1.38" (34.9)	2.13" (54.1)	0.312" (7.9)	20,000 PSI 1380 bar
3/4" M/P	37	1.38" (34.9)	5.08" (129.0)	0.437" (11.1)	20,000 PSI 1380 bar
1" M/P	49	1.38" (35.1)	3.21" (81.5)	0.437" (11.1)	20,000 PSI 1380 bar

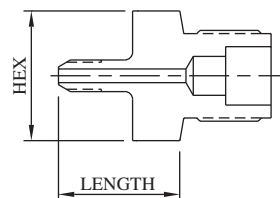

FEMALE H/P CONED AND THREADED TUBE

Connection	Suffix	Hex	Length	Port	MAWP*
1/4" H/P	23	1.38" (34.9)	1.02" (25.9)	0.083" (2.1)	20,000 PSI 1380 bar
3/8" H/P	24	1.38" (34.9)	1.04" (26.4)	0.125" (3.2)	20,000 PSI 1380 bar
9/16" H/P	25	1.38" (34.9)	1.13" (28.7)	0.187" (4.7)	20,000 PSI 1380 bar

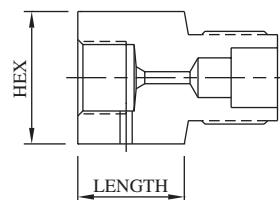

MALE H/P CONED AND THREADED TUBE

Connection	Suffix	Hex	Length	Port	MAWP*
1/4" H/P	9	1.00" (25.4)	1.98" (50.3)	0.083" (2.1)	20,000 PSI 1380 bar
3/8" H/P	30	1.00" (25.4)	2.38" (60.5)	0.125" (3.2)	20,000 PSI 1380 bar
9/16" H/P	42	1.00" (25.4)	2.85" (72.4)	0.188" (4.8)	20,000 PSI 1380 bar

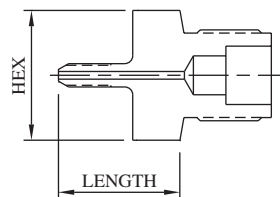

***CAUTION:** The maximum allowable working pressure (MAWP) of the valve shall not exceed the MAWP of the valve series or the selected connection, whichever is less.

All dimensions are for reference only and are subject to change.
Dimensions in parentheses are millimeters (mm).

上海兆帕流体动力有限公司 / Shanghai MPA Fluid Power Co.,Ltd.
Web: www.mpapower.com / E-mail: info@mpapower.com



TRUNNION VALVE FLOW CONFIGURATIONS

3-way Diverting P/N 3DVK*

3-way diverting ball valves are designed to divert media from a single source to one of two separate lines. The 90° quarter-turn design allows for continuous on-line service.

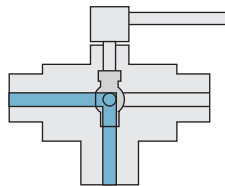

Open

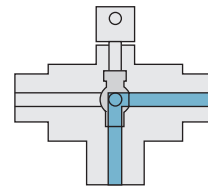

Open

3-way Switching P/N 3K*

3-way switching ball valves are designed to direct media from bottom inlet port to one of two separate lines. The 180° quarter-turn design allows for positive shutoff in the center position.

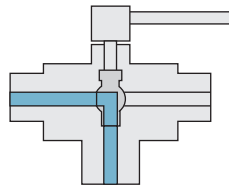

Open

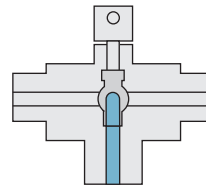

Closed

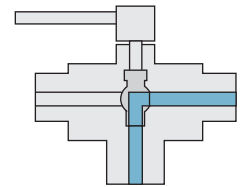

Open

4-way P/N 4K*

4-way ball valves utilize a double-ported ball for crossover of two flows. The 90° quarter-turn design allows for continuous on-line service. The valve can be used in place of a three valve manifold

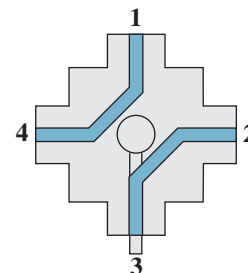
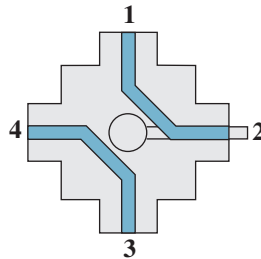

5-way P/N 5K*

5-way ball valves direct media flow from a single bottom inlet to one of four separate lines. The 360° quarter-turn design allows for continuous on-line service.

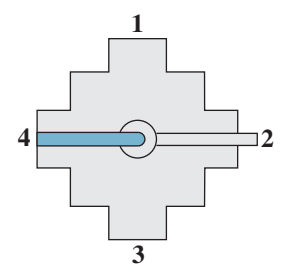
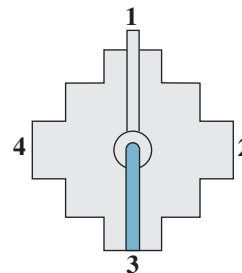
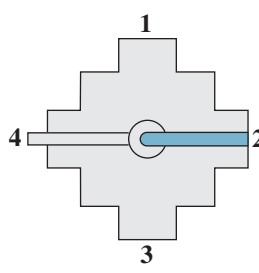
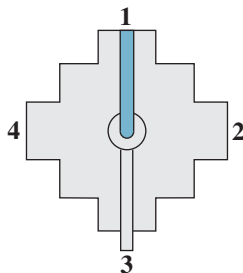

All BuTech Ball Valves are capable of bi-directional flow.

All dimensions are for reference only and are subject to change.
Dimensions in parentheses are millimeters (mm).

3000 PSI (210 BAR) 3-WAY TRUNNION VALVES

Mounting:

Panel: 0.78" (19.8 mm) dia
0.37" (9.4 mm) max thickness

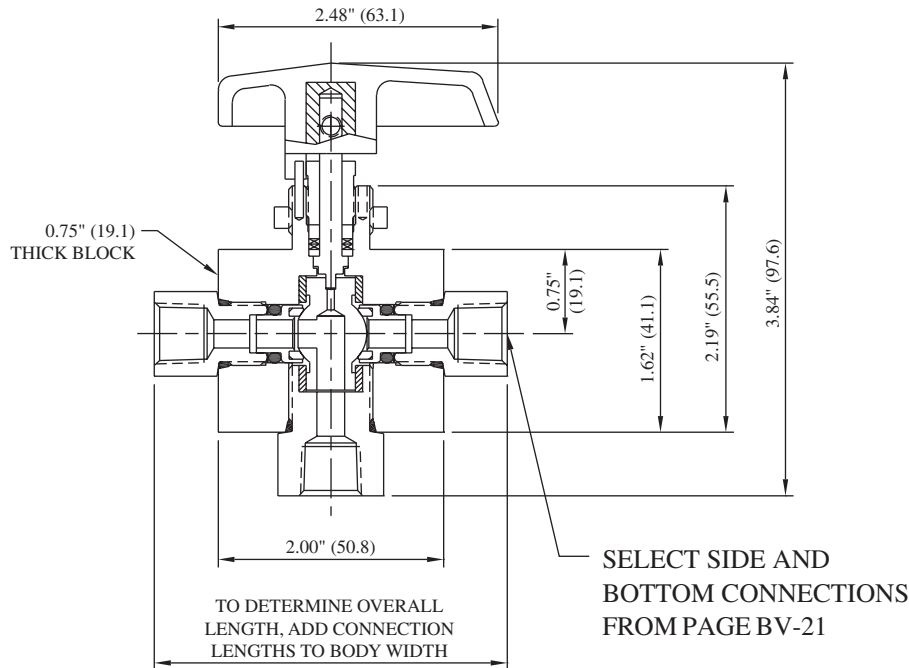

Model No. 3K34
3DVK34

*MAWP: 3,000 PSI (210 bar)
Port: 0.250" (6.4 mm)
Cv: 1.00

Materials of Construction:

- 316 cold-worked stainless steel body and side adapters
- 316 cold-worked stem
- PEEK ball seals
- Glass-filled Teflon stem packings
- Viton O-rings

Ordering information and options on page BV-2

Repair Kit P/N's **RK-3K34** and **RK-3DVK34** contain trunnion, trunnion seals and seal retainers, o-rings, pins, stem, stem packings, and washers

For replacement connections, use prefix number **40-** and suffix number. Ex: 40-20

FEMALE PIPE

Connection	For Side Connections				For Bottom Connection				MAWP*
	Suffix	Hex	Length	Port	Suffix	Hex	Length	Port	
1/8" FNPT	19	0.75" (19.1)	0.58" (14.7)	0.250" (6.4)	19B	0.75" (19.1)	0.43" (10.9)	0.250" (6.4)	15,000 PSI 1030 bar
1/4" FNPT	20	0.75" (19.1)	0.58" (14.7)	0.250" (6.4)	20B	0.75" (19.1)	0.73" (18.5)	0.250" (6.4)	15,000 PSI 1030 bar
3/8" FNPT	21	1.00" (25.4)	0.75" (19.1)	0.250" (6.4)	21B	1.00" (25.4)	0.81" (20.6)	0.250" (6.4)	15,000 PSI 1030 bar
1/2" FNPT	22	1.18" (30.0)	1.00" (25.4)	0.250" (6.4)	22B	1.18" (30.0)	0.96" (24.4)	0.250" (6.4)	15,000 PSI 1030 bar

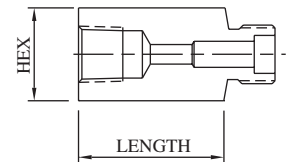

MALE PIPE

Connection	For Side Connections				For Bottom Connection				MAWP*
	Suffix	Hex	Length	Port	Suffix	Hex	Length	Port	
1/8" MNPT	4	0.75" (19.1)	0.97" (24.6)	0.250" (6.4)	4B	0.75" (19.1)	0.97" (24.6)	0.250" (6.4)	15,000 PSI 1030 bar
1/4" MNPT	5	0.75" (19.1)	1.19" (30.2)	0.250" (6.4)	5B	0.75" (19.1)	1.19" (30.2)	0.250" (6.4)	15,000 PSI 1030 bar
3/8" MNPT	6	1.00" (25.4)	1.30" (33.0)	0.250" (6.4)	6B	1.00" (25.4)	1.30" (33.0)	0.250" (6.4)	15,000 PSI 1030 bar
1/2" MNPT	7	1.00" (25.4)	1.55" (39.4)	0.250" (6.4)	7B	1.00" (25.4)	1.55" (39.4)	0.250" (6.4)	15,000 PSI 1030 bar

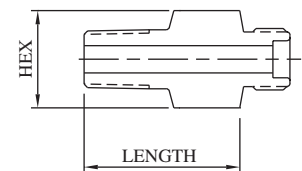

***CAUTION:** The maximum allowable working pressure (MAWP) of the valve shall not exceed the MAWP of the valve series or the selected connection, whichever is less.

All dimensions are for reference only and are subject to change.
Dimensions in parentheses are millimeters (mm).

上海兆帕流体动力有限公司 / Shanghai MPA Fluid Power Co., Ltd.
Web: www.mpapower.com / E-mail: info@mpapower.com



6000 PSI (410 BAR) 3-WAY TRUNNION VALVES

Model No. **3K63**
3DVK63

Mounting:

Panel: 0.91" (23.0 mm) dia
 0.31" (7.8 mm) max thickness

*MAWP: 6,000 PSI (410 bar)
 Port: 0.187" (4.7 mm)
 Cv: 0.56

Materials of Construction:

- 316 cold-worked stainless steel body and side adapters
- 316 cold-worked stem
- PEEK ball seals
- Glass-filled Teflon stem packings
- Viton O-rings

Ordering information and options on page BV-2

Repair Kit P/N's RK-3K63 and RK-3DVK63 contain trunnion, trunnion seals and seal retainers, o-rings, spring washers, stem, stem packings, and washers

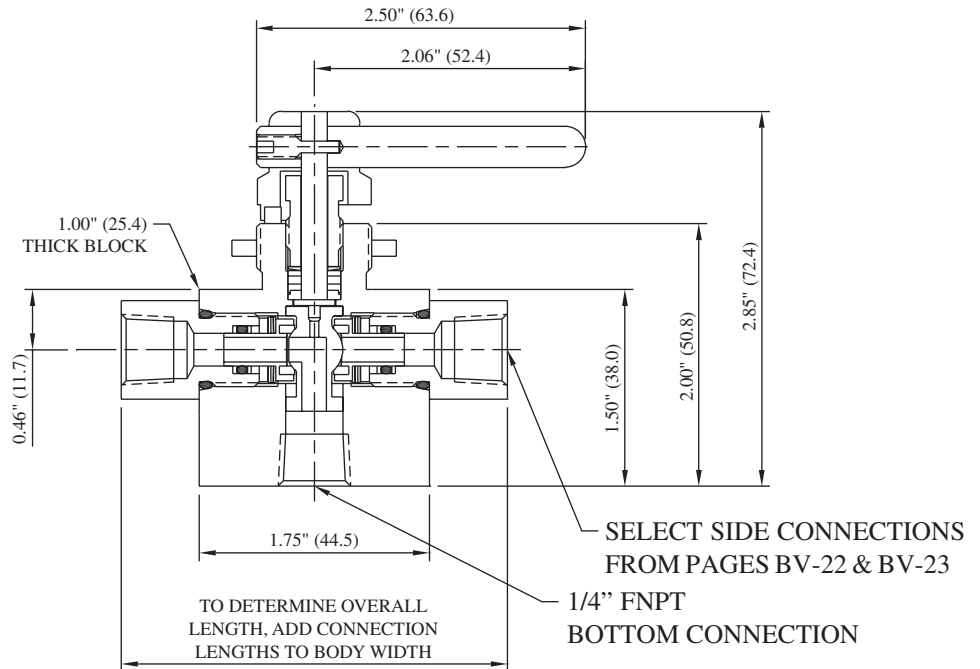

For replacement connections, use prefix number **3-** and suffix number. Ex: 3-20

FEMALE PIPE

Connection	For Side Connections				For Bottom Connection				MAWP*
	Suffix	Hex	Length	Port	Suffix	Hex	Length	Port	
1/8" FNPT	19	0.75" (19.1)	0.60" (15.2)	0.250" (6.4)	19B	1.00" (25.4)	0.63" (16.0)	0.250" (6.4)	15,000 PSI 1030 bar
1/4" FNPT	20	0.75" (19.1)	0.60" (15.2)	0.250" (6.4)	20B	1.00" (25.4)	0.55" (14.0)	0.250" (6.4)	15,000 PSI 1030 bar
3/8" FNPT	21	1.00" (25.4)	1.01" (25.7)	0.250" (6.4)	21B	1.00" (25.4)	1.01" (25.7)	0.250" (6.4)	15,000 PSI 1030 bar
1/2" FNPT	22	1.00" (25.4)	1.01" (25.7)	0.250" (6.4)	22B	1.00" (25.4)	1.16" (29.5)	0.250" (6.4)	15,000 PSI 1030 bar

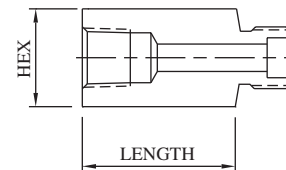

MALE PIPE

Connection	For Side Connections				For Bottom Connection				MAWP*
	Suffix	Hex	Length	Port	Suffix	Hex	Length	Port	
1/8" MNPT	4	0.75" (19.1)	1.01" (25.7)	0.125" (3.2)	4B	1.00" (25.4)	0.93" (23.6)	0.125" (3.2)	15,000 PSI 1030 bar
1/4" MNPT	5	0.75" (19.1)	1.01" (25.7)	0.250" (6.4)	5B	1.00" (25.4)	1.05" (26.7)	0.250" (6.4)	15,000 PSI 1030 bar
3/8" MNPT	6	0.75" (19.1)	1.01" (25.7)	0.250" (6.4)	6B	1.00" (25.4)	1.01" (25.7)	0.250" (6.4)	15,000 PSI 1030 bar
1/2" MNPT	7	1.00" (25.4)	1.26" (32.0)	0.250" (6.4)	7B	1.00" (25.4)	1.29" (32.8)	0.250" (6.4)	15,000 PSI 1030 bar

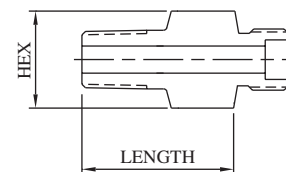

***CAUTION:** The maximum allowable working pressure (MAWP) of the valve shall not exceed the MAWP of the valve series or the selected connection, whichever is less.

All dimensions are for reference only and are subject to change.
 Dimensions in parentheses are millimeters (mm).



上海兆帕流体动力有限公司 / Shanghai MPA Fluid Power Co.,Ltd.
 Web: www.mpapower.com / E-mail: info@mpapower.com

6000 PSI (410 BAR) 3-WAY TRUNNION VALVES

Model No. **3K63**
3DVK63

FEMALE SINGLE-FERRULE TUBE

For Side Connections					
Connection	Suffix	Hex	Length	Port	MAWP*
1/8" L/P	12	0.75" (19.1)	0.78" (19.8)	0.093" (2.4)	15,000 PSI 1030 bar
1/4" SL/P	13	0.75" (19.1)	1.03" (26.2)	0.125" (3.2)	11,500 PSI 790 bar
3/8" SL/P	14	0.75" (19.1)	1.03" (26.2)	0.250" (6.4)	7,500 PSI 520 bar
1/2" L/P	15	1.00" (25.4)	1.03" (26.2)	0.250" (6.4)	5,500 PSI 380 bar

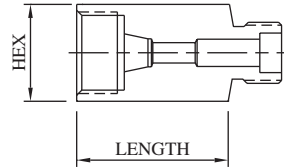

FEMALE M/P CONED AND THREADED TUBE

For Side Connections					
Connection	Suffix	Hex	Length	Port	MAWP*
1/4" M/P	16	0.75" (19.1)	0.74" (18.8)	0.109" (2.8)	20,000 PSI 1380 bar
3/8" M/P	17	0.75" (19.1)	1.01" (25.7)	0.203" (5.2)	20,000 PSI 1380 bar
9/16" M/P	18	1.00" (25.4)	1.26" (32.0)	0.250" (6.4)	20,000 PSI 1380 bar

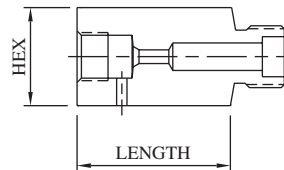

MALE M/P CONED AND THREADED TUBE

For Side Connections					
Connection	Suffix	Hex	Length	Port	MAWP*
1/4" M/P	8	0.75" (19.1)	1.88" (47.8)	0.109" (2.8)	20,000 PSI 1380 bar
3/8" M/P	10	0.75" (19.1)	2.00" (50.8)	0.203" (5.2)	20,000 PSI 1380 bar
9/16" M/P	11	1.00" (25.4)	2.31" (58.7)	0.250" (6.4)	20,000 PSI 1380 bar

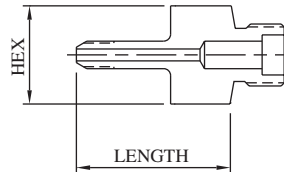

FEMALE H/P CONED AND THREADED TUBE

For Side Connections					
Connection	Suffix	Hex	Length	Port	MAWP*
1/4" H/P	23	0.75" (19.1)	1.01" (25.7)	0.093" (2.4)	20,000 PSI 1380 bar
3/8" H/P	24	1.00" (25.4)	1.17" (29.7)	0.125" (3.2)	20,000 PSI 1380 bar
9/16" H/P	25	1.37" (34.8)	1.25" (31.8)	0.187" (4.7)	20,000 PSI 1380 bar

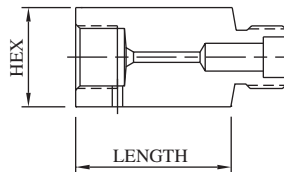

MALE H/P CONED AND THREADED TUBE

For Side Connections					
Connection	Suffix	Hex	Length	Port	MAWP*
1/4" H/P	9	0.75" (19.1)	1.94" (49.3)	0.083" (2.1)	20,000 PSI 1380 bar
3/8" H/P	30	0.75" (19.1)	2.25" (57.2)	0.125" (3.2)	20,000 PSI 1380 bar
9/16" H/P	42	0.75" (19.1)	2.82" (71.6)	0.187" (4.7)	20,000 PSI 1380 bar

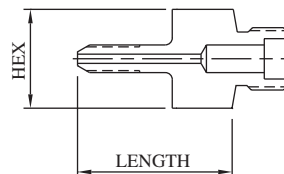

***CAUTION:** The maximum allowable working pressure (MAWP) of the valve shall not exceed the MAWP of the valve series or the selected connection, whichever is less.

All dimensions are for reference only and are subject to change.
Dimensions in parentheses are millimeters (mm).

上海兆帕流体动力有限公司 / Shanghai MPA Fluid Power Co.,Ltd.
Web: www.mpapower.com / E-mail: info@mpapower.com



10,000 PSI (690 BAR) 3-WAY TRUNNION VALVES

**Model No. 3K93
3DVK93**

Mounting:

Panel: 0.91" (23.0 mm) dia
0.31" (7.8 mm) max thickness

*MAWP: 10,000 PSI (690 bar)
Port: 0.187" (4.7 mm)
Cv: 0.56

Materials of Construction:

- 316 cold-worked stainless steel body and side adapters
- 316 cold-worked stem
- PEEK ball seals
- Glass-filled Teflon stem packings
- Viton O-rings

Ordering information and options on page BV-2

Repair Kit P/N's RK-3K93 and RK-3DVK93 contain trunnion, trunnion seals and seal retainers, o-rings, stem, stem packings, and spring washers

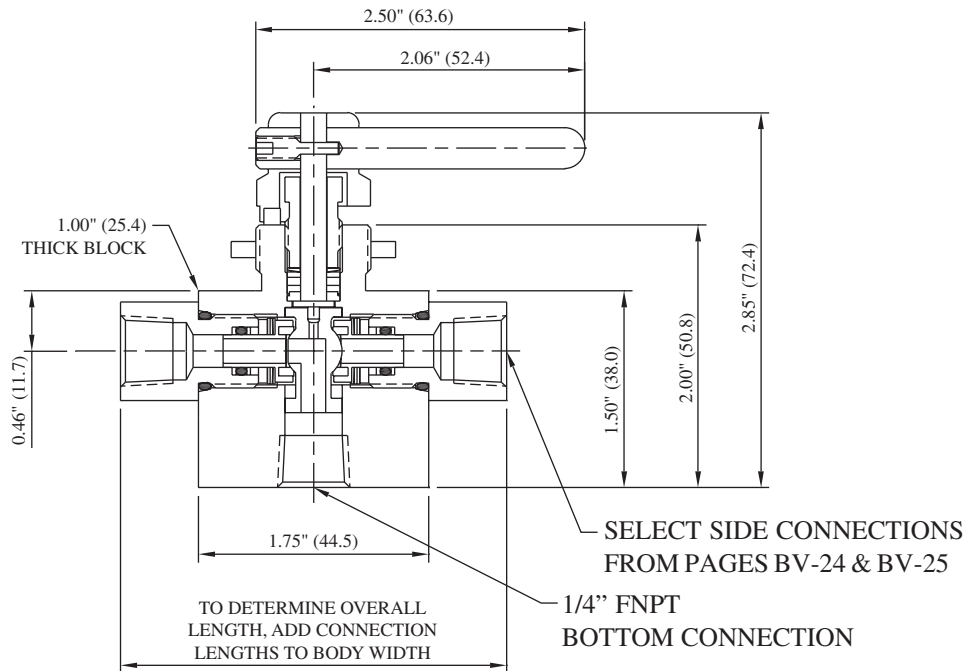

For replacement connections, use prefix number **3-** and suffix number. Ex: 3-20

FEMALE PIPE

Connection	For Side Connections				For Bottom Connection				MAWP*
	Suffix	Hex	Length	Port	Suffix	Hex	Length	Port	
1/8" FNPT	19	0.75" (19.1)	0.60" (15.2)	0.250" (6.4)	19B	1.00" (25.4)	0.63" (16.0)	0.250" (6.4)	15,000 PSI 1030 bar
1/4" FNPT	20	0.75" (19.1)	0.60" (15.2)	0.250" (6.4)	20B	1.00" (25.4)	0.55" (14.0)	0.250" (6.4)	15,000 PSI 1030 bar
3/8" FNPT	21	1.00" (25.4)	1.01" (25.7)	0.250" (6.4)	21B	1.00" (25.4)	1.01" (25.7)	0.250" (6.4)	15,000 PSI 1030 bar
1/2" FNPT	22	1.00" (25.4)	1.01" (25.7)	0.250" (6.4)	22B	1.00" (25.4)	1.16" (29.5)	0.250" (6.4)	15,000 PSI 1030 bar

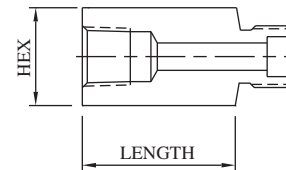

MALE PIPE

Connection	For Side Connections				For Bottom Connection				MAWP*
	Suffix	Hex	Length	Port	Suffix	Hex	Length	Port	
1/8" MNPT	4	0.75" (19.1)	1.01" (25.7)	0.125" (3.2)	4B	1.00" (25.4)	0.93" (23.6)	0.125" (3.2)	15,000 PSI 1030 bar
1/4" MNPT	5	0.75" (19.1)	1.01" (25.7)	0.250" (6.4)	5B	1.00" (25.4)	1.05" (26.7)	0.250" (6.4)	15,000 PSI 1030 bar
3/8" MNPT	6	0.75" (19.1)	1.01" (25.7)	0.250" (6.4)	6B	1.00" (25.4)	1.01" (25.7)	0.250" (6.4)	15,000 PSI 1030 bar
1/2" MNPT	7	1.00" (25.4)	1.26" (32.0)	0.250" (6.4)	7B	1.00" (25.4)	1.29" (32.8)	0.250" (6.4)	15,000 PSI 1030 bar

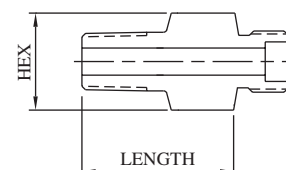

***CAUTION:** The maximum allowable working pressure (MAWP) of the valve shall not exceed the MAWP of the valve series or the selected connection, whichever is less.

All dimensions are for reference only and are subject to change.
Dimensions in parentheses are millimeters (mm).



上海兆帕流体动力有限公司 / Shanghai MPA Fluid Power Co.,Ltd.
Web: www.mpapower.com / E-mail: info@mpapower.com

10,000 PSI (690 BAR) 3-WAY TRUNNION VALVES

Model No. **3K93**
3DVK93

FEMALE SINGLE-FERRULE TUBE

For Side Connections					
Connection	Suffix	Hex	Length	Port	MAWP*
1/8" L/P	12	0.75" (19.1)	0.78" (19.8)	0.093" (2.4)	15,000 PSI 1030 bar
1/4" SL/P	13	0.75" (19.1)	1.03" (26.2)	0.125" (3.2)	11,500 PSI 790 bar
3/8" SL/P	14	0.75" (19.1)	1.03" (26.2)	0.250" (6.4)	7,500 PSI 520 bar
1/2" L/P	15	1.00" (25.4)	1.03" (26.2)	0.250" (6.4)	5,500 PSI 380 bar

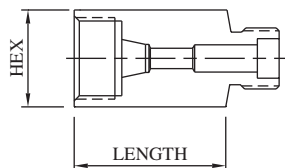

FEMALE M/P CONED AND THREADED TUBE

For Side Connections					
Connection	Suffix	Hex	Length	Port	MAWP*
1/4" M/P	16	0.75" (19.1)	0.74" (18.8)	0.109" (2.8)	20,000 PSI 1380 bar
3/8" M/P	17	0.75" (19.1)	1.01" (25.7)	0.203" (5.2)	20,000 PSI 1380 bar
9/16" M/P	18	1.00" (25.4)	1.26" (32.0)	0.250" (6.4)	20,000 PSI 1380 bar

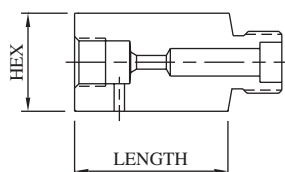

MALE M/P CONED AND THREADED TUBE

For Side Connections					
Connection	Suffix	Hex	Length	Port	MAWP*
1/4" M/P	8	0.75" (19.1)	1.88" (47.8)	0.109" (2.8)	20,000 PSI 1380 bar
3/8" M/P	10	0.75" (19.1)	2.00" (50.8)	0.203" (5.2)	20,000 PSI 1380 bar
9/16" M/P	11	1.00" (25.4)	2.31" (58.7)	0.250" (6.4)	20,000 PSI 1380 bar

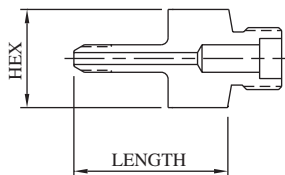

FEMALE H/P CONED AND THREADED TUBE

For Side Connections					
Connection	Suffix	Hex	Length	Port	MAWP*
1/4" H/P	23	0.75" (19.1)	1.01" (25.7)	0.093" (2.4)	20,000 PSI 1380 bar
3/8" H/P	24	1.00" (25.4)	1.17" (29.7)	0.125" (3.2)	20,000 PSI 1380 bar
9/16" H/P	25	1.37" (34.8)	1.25" (31.8)	0.187" (4.7)	20,000 PSI 1380 bar

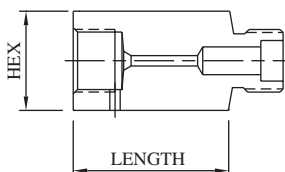

MALE H/P CONED AND THREADED TUBE

For Side Connections					
Connection	Suffix	Hex	Length	Port	MAWP*
1/4" H/P	9	0.75" (19.1)	1.94" (49.3)	0.083" (2.1)	20,000 PSI 1380 bar
3/8" H/P	30	0.75" (19.1)	2.25" (57.2)	0.125" (3.2)	20,000 PSI 1380 bar
9/16" H/P	42	0.75" (19.1)	2.82" (71.6)	0.187" (4.7)	20,000 PSI 1380 bar

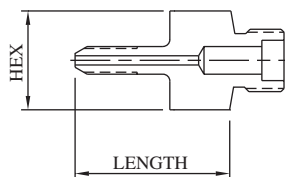

***CAUTION:** The maximum allowable working pressure (MAWP) of the valve shall not exceed the MAWP of the valve series or the selected connection, whichever is less.

All dimensions are for reference only and are subject to change.
Dimensions in parentheses are millimeters (mm).

上海兆帕流体动力有限公司 / Shanghai MPA Fluid Power Co.,Ltd.
Web: www.mpapower.com / E-mail: info@mpapower.com



10,000 PSI (690 BAR) 3-WAY TRUNNION VALVES

Model No. 3K106
3DVK106

*MAWP: 10,000 PSI (690 bar)
Port: 0.375" (9.5 mm)
Cv: 2.40

Materials of Construction:

- 316 cold-worked stainless steel body and side adapters
- 17-4PH stem
- PEEK ball seals
- Viton O-rings
- Teflon back-ups

Ordering information and options on page BV-2

Repair Kit P/N's RK-3K106 and RK-3DVK106 contain stem, trunnion, trunnion seals and seal retainers, o-rings, backups, spring washers, and bearing washers

FEMALE PIPE

Connection	For Side Connections				For Bottom Connection				MAWP*
	Suffix	Hex	Length	Port	Suffix	Hex	Length	Port	
1/8" FNPT	19	1.38" (35.1)	0.47" (11.9)	0.339" (8.6)	19B	1.38" (35.1)	0.47" (11.9)	0.339" (8.6)	15,000 PSI 1030 bar
1/4" FNPT	20	1.38" (35.1)	1.00" (25.4)	0.437" (11.1)	20B	1.38" (35.1)	1.06" (26.9)	0.375" (9.5)	15,000 PSI 1030 bar
3/8" FNPT	21	1.38" (35.1)	1.00" (25.4)	0.500" (12.7)	21B	1.38" (35.1)	1.06" (26.9)	0.375" (9.5)	15,000 PSI 1030 bar
1/2" FNPT	22	1.38" (35.1)	1.00" (25.4)	0.500" (12.7)	22B	1.38" (35.1)	1.06" (26.9)	0.375" (9.5)	15,000 PSI 1030 bar
3/4" FNPT	41	1.38" (35.1)	1.10" (27.9)	0.500" (12.7)	41B	1.38" (35.1)	1.17" (29.7)	0.375" (9.5)	10,000 PSI 690 bar
1" FNPT	45	1.75" (44.5)	1.75" (44.5)	0.500" (12.7)	45B	1.75" (44.5)	1.75" (44.5)	0.500" (12.7)	10,000 PSI 690 bar

MALE PIPE

Connection	For Side Connections				For Bottom Connection				MAWP*
	Suffix	Hex	Length	Port	Suffix	Hex	Length	Port	
1/8" MNPT	4	1.38" (35.1)	1.08" (27.4)	0.187" (4.7)	4B	1.38" (35.1)	1.09" (27.7)	0.187" (4.7)	15,000 PSI 1030 bar
1/4" MNPT	5	1.38" (35.1)	1.22" (31.0)	0.250" (6.4)	5B	1.38" (35.1)	1.31" (33.3)	0.250" (6.4)	15,000 PSI 1030 bar
3/8" MNPT	6	1.38" (35.1)	1.23" (31.2)	0.375" (9.5)	6B	1.38" (35.1)	1.43" (36.3)	0.375" (9.5)	15,000 PSI 1030 bar
1/2" MNPT	7	1.38" (35.1)	1.59" (40.4)	0.375" (9.5)	7B	1.38" (35.1)	1.63" (41.4)	0.375" (9.5)	15,000 PSI 1030 bar
3/4" MNPT	55	1.38" (35.1)	1.62" (41.1)	0.500" (12.7)	55B	1.38" (35.1)	1.65" (41.9)	0.375" (9.5)	10,000 PSI 690 bar
1" MNPT	56	1.50" (38.1)	1.87" (47.5)	0.500" (12.7)	56B	1.50" (38.1)	1.90" (48.3)	0.375" (9.5)	10,000 PSI 690 bar

Mounting:

Panel: 1.06" (26.9 mm) dia
0.25" (6.3 mm) max thickness
Side: 0.28" (7.1 mm) dia

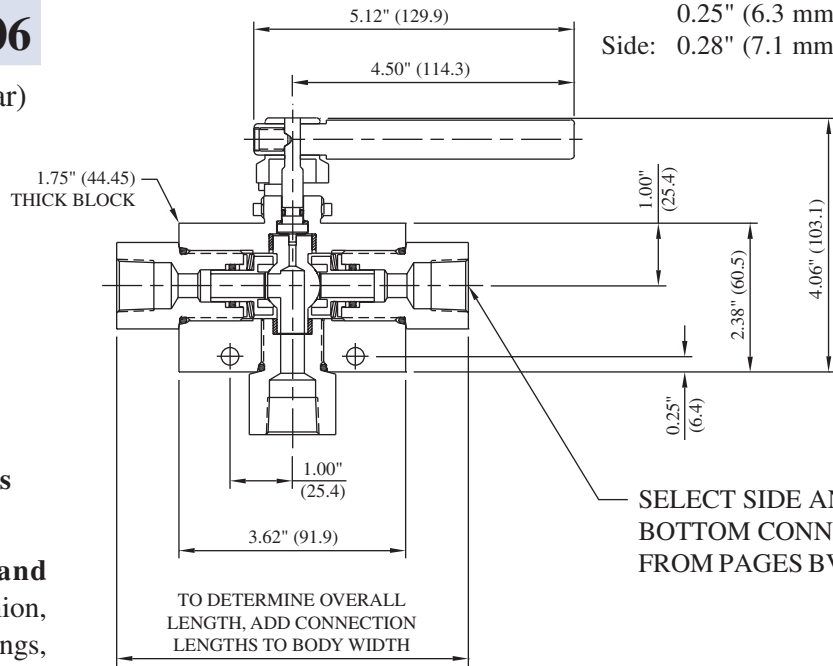

SELECT SIDE AND BOTTOM CONNECTIONS FROM PAGES BV-26 & BV-27

For replacement connections, use prefix number **36-** and suffix number. Ex: 36-20

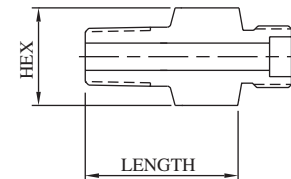
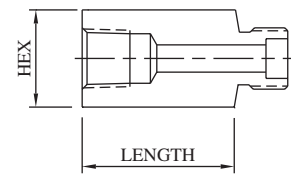

***CAUTION:** The maximum allowable working pressure (MAWP) of the valve shall not exceed the MAWP of the valve series or the selected connection, whichever is less.

All dimensions are for reference only and are subject to change.
Dimensions in parentheses are millimeters (mm).



上海兆帕流体动力有限公司 / Shanghai MPA Fluid Power Co.,Ltd.
Web: www.mpapower.com / E-mail: info@mpapower.com

10,000 PSI (690 BAR) 3-WAY TRUNNION VALVES

Model No. **3K106**
3DVK106

FEMALE SINGLE-FERRULE TUBE

Connection	For Side Connections				For Bottom Connection				MAWP*
	Suffix	Hex	Length	Port	Suffix	Hex	Length	Port	
1/4" SL/P	13	1.38" (35.1)	0.64" (16.3)	0.187" (4.7)	13B	1.38" (35.1)	0.66" (16.8)	0.187" (4.7)	11,500 PSI 790 bar
3/8" SL/P	14	1.38" (35.1)	0.75" (19.1)	0.312" (7.9)	14B	1.38" (35.1)	0.75" (19.1)	0.312" (7.9)	7,500 PSI 520 bar
1/2" L/P	15	1.38" (35.1)	1.06" (26.9)	0.437" (11.1)	15B	1.38" (35.1)	1.06" (26.9)	0.375" (9.5)	5,500 PSI 380 bar

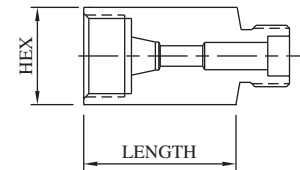

FEMALE M/P CONED AND THREADED TUBE

Connection	For Side Connections				For Bottom Connection				MAWP*
	Suffix	Hex	Length	Port	Suffix	Hex	Length	Port	
1/4" M/P	16	1.38" (35.1)	0.65" (16.5)	0.109" (2.8)	16B	1.38" (35.1)	0.72" (18.3)	0.109" (2.8)	20,000 PSI 1380 bar
3/8" M/P	17	1.38" (35.1)	1.06" (26.9)	0.203" (5.2)	17B	1.38" (35.1)	1.06" (26.9)	0.203" (5.2)	20,000 PSI 1380 bar
9/16" M/P	18	1.38" (35.1)	1.31" (33.3)	0.312" (7.9)	18B	1.38" (35.1)	1.06" (26.9)	0.312" (7.9)	20,000 PSI 1380 bar
3/4" M/P	32	1.38" (35.1)	1.52" (38.6)	0.437" (11.1)	32B	1.38" (35.1)	1.18" (30.0)	0.375" (9.5)	20,000 PSI 1380 bar
1" M/P	43	1.75" (44.5)	1.91" (48.5)	0.500" (12.7)	43B	1.75" (44.5)	1.99" (50.5)	0.375" (9.5)	20,000 PSI 1380 bar

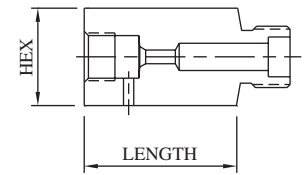

MALE M/P CONED AND THREADED TUBE

Connection	For Side Connections				For Bottom Connection				MAWP*
	Suffix	Hex	Length	Port	Suffix	Hex	Length	Port	
1/4" M/P	8	1.38" (35.1)	1.91" (48.5)	0.109" (2.8)	8B	1.38" (35.1)	1.93" (49.0)	0.109" (2.8)	20,000 PSI 1380 bar
3/8" M/P	10	1.38" (35.1)	1.87" (47.5)	0.203" (5.2)	10B	1.38" (35.1)	2.17" (55.1)	0.203" (5.2)	20,000 PSI 1380 bar
9/16" M/P	11	1.38" (35.1)	3.21" (81.5)	0.312" (7.9)	11B	1.38" (35.1)	2.18" (55.4)	0.312" (7.9)	20,000 PSI 1380 bar
3/4" M/P	37	1.38" (35.1)	3.54" (89.9)	0.437" (11.1)	37B	1.38" (35.1)	5.06" (128.5)	0.437" (11.1)	20,000 PSI 1380 bar
1" M/P	49	1.38" (35.1)	3.20" (81.3)	0.500" (12.7)	49B	1.38" (35.1)	3.25" (82.6)	0.500" (12.7)	20,000 PSI 1380 bar

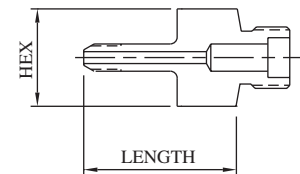

FEMALE H/P CONED AND THREADED TUBE

Connection	For Side Connections				For Bottom Connection				MAWP*
	Suffix	Hex	Length	Port	Suffix	Hex	Length	Port	
1/4" H/P	23	1.38" (35.1)	0.58" (14.7)	0.093" (2.4)	23B	1.38" (35.1)	0.60" (15.2)	0.093" (2.4)	20,000 PSI 1380 bar
3/8" H/P	24	1.38" (35.1)	0.89" (22.6)	0.125" (3.2)	24B	1.38" (35.1)	0.91" (23.1)	0.125" (3.2)	20,000 PSI 1380 bar
9/16" H/P	25	1.50" (38.1)	0.98" (24.9)	0.187" (4.7)	25B	1.50" (38.1)	1.02" (25.9)	0.187" (4.7)	20,000 PSI 1380 bar

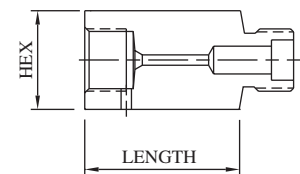

MALE H/P CONED AND THREADED TUBE

Connection	For Side Connections				For Bottom Connection				MAWP*
	Suffix	Hex	Length	Port	Suffix	Hex	Length	Port	
1/4" H/P	9	1.38" (35.1)	2.16" (54.9)	0.083" (2.1)	9B	1.38" (35.1)	2.19" (55.6)	0.083" (2.1)	20,000 PSI 1380 bar
3/8" H/P	30	1.38" (35.1)	2.40" (61.0)	0.125" (3.2)	30B	1.38" (35.1)	2.42" (61.5)	0.125" (3.2)	20,000 PSI 1380 bar
9/16" H/P	42	1.38" (35.1)	2.89" (73.4)	0.187" (4.7)	42B	1.38" (35.1)	2.92" (74.2)	0.187" (4.7)	20,000 PSI 1380 bar

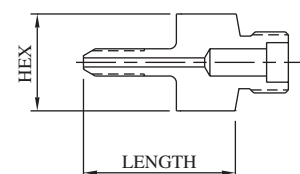

***CAUTION:** The maximum allowable working pressure (MAWP) of the valve shall not exceed the MAWP of the valve series or the selected connection, whichever is less.

All dimensions are for reference only and are subject to change.
Dimensions in parentheses are millimeters (mm).

上海兆帕流体动力有限公司 / Shanghai MPA Fluid Power Co., Ltd.
Web: www.mpapower.com / E-mail: info@mpapower.com



10,000 PSI (690 BAR) 3-WAY TRUNNION VALVES

**Model No. 3K108
3DVK108**

Mounting:

Side: 0.28" (7.1 mm) dia

*MAWP: 10,000 PSI (690 bar)
Port: 0.500" (12.7 mm)
Cv: 5.00

Materials of Construction:

- 316 cold-worked stainless steel body and side adapters
- 17-4PH stem
- PEEK ball seals
- Glass-filled Teflon stem packings
- Viton O-rings

Ordering information and options on page BV-2

Repair Kit P/N's RK-3K108 and RK-3DVK108 contain trunnion, trunnion seals and seal retainers, o-rings, spring washers, gaskets, stem, stem packings and washers

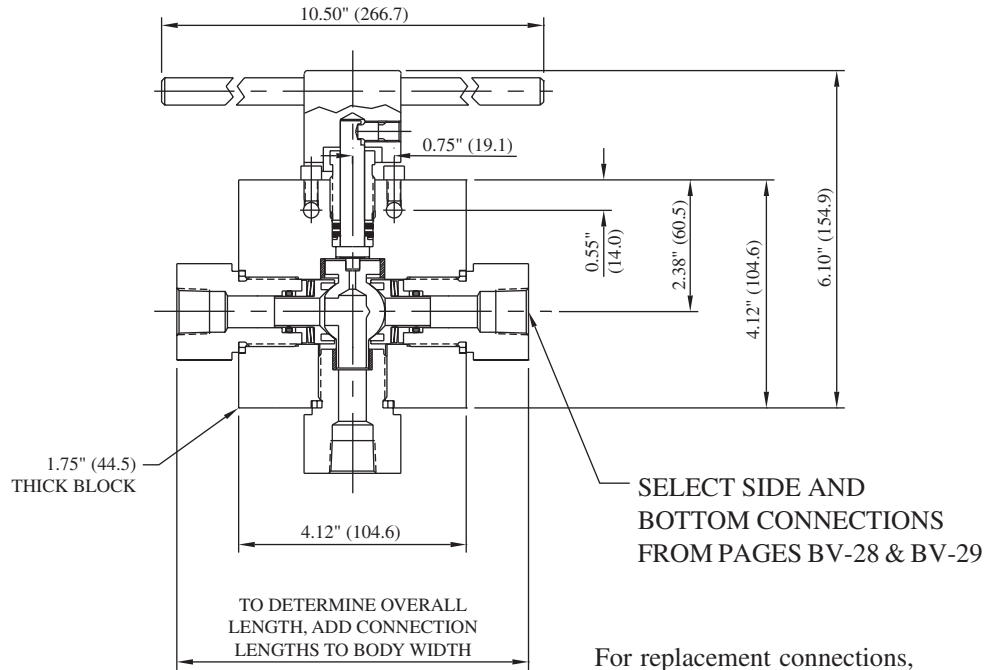

For replacement connections, use prefix number **38-** and suffix number. Ex: 38-20

FEMALE PIPE

Connection	For Side Connections				For Bottom Connection				MAWP*
	Suffix	Hex	Length	Port	Suffix	Hex	Length	Port	
3/8" FNPT	21	1.75" (44.5)	1.11" (28.2)	0.437" (11.1)	21B	1.75" (44.5)	1.19" (30.2)	0.437" (11.1)	15,000 PSI 1030 bar
1/2" FNPT	22	1.75" (44.5)	1.11" (28.2)	0.580" (14.7)	22B	1.75" (44.5)	1.19" (30.2)	0.500" (12.7)	15,000 PSI 1030 bar
3/4" FNPT	41	1.75" (44.5)	1.21" (30.7)	0.580" (14.7)	41B	1.75" (44.5)	1.33" (33.8)	0.500" (12.7)	10,000 PSI 690 bar
1" FNPT	45	1.75" (44.5)	1.37" (34.8)	0.580" (14.7)	45B	1.75" (44.5)	1.70" (43.2)	0.500" (12.7)	10,000 PSI 690 bar
1-1/2" FNPT	46	2.50" (63.5)	1.75" (44.5)	0.580" (14.7)	46B	2.50" (63.5)	1.75" (44.5)	0.500" (12.7)	5,000 PSI 340 bar

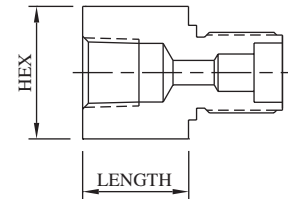

MALE PIPE

Connection	For Side Connections				For Bottom Connection				MAWP*
	Suffix	Hex	Length	Port	Suffix	Hex	Length	Port	
3/8" MNPT	6	1.75" (44.5)	1.43" (36.3)	0.375" (9.5)	6B	1.75" (44.5)	1.43" (36.3)	0.375" (9.5)	15,000 PSI 1030 bar
1/2" MNPT	7	1.75" (44.5)	1.65" (41.9)	0.580" (14.7)	7B	1.75" (44.5)	1.67" (42.4)	0.500" (12.7)	15,000 PSI 1030 bar
3/4" MNPT	55	1.75" (44.5)	1.67" (42.4)	0.580" (14.7)	55B	1.75" (44.5)	1.75" (44.5)	0.500" (12.7)	10,000 PSI 690 bar
1" MNPT	56	1.75" (44.5)	1.85" (47.0)	0.580" (14.7)	56B	1.75" (44.5)	1.86" (47.2)	0.500" (12.7)	10,000 PSI 690 bar
1-1/2" MNPT	121	2.12" (53.8)	1.89" (48.0)	0.580" (14.7)	121B	2.12" (53.8)	1.89" (48.0)	0.500" (12.7)	5,000 PSI 340 bar

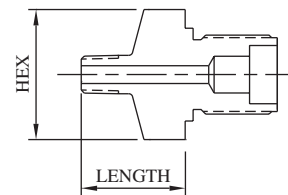

***CAUTION:** The maximum allowable working pressure (MAWP) of the valve shall not exceed the MAWP of the valve series or the selected connection, whichever is less.

All dimensions are for reference only and are subject to change.
Dimensions in parentheses are millimeters (mm).



上海兆帕流体动力有限公司 / Shanghai MPA Fluid Power Co.,Ltd.
Web: www.mpapower.com / E-mail: info@mpapower.com

10,000 PSI (690 BAR) 3-WAY TRUNNION VALVES

Model No. 3K108
3DVK108

FEMALE SINGLE-FERRULE TUBE

Connection	For Side Connections				For Bottom Connection				MAWP*
	Suffix	Hex	Length	Port	Suffix	Hex	Length	Port	
3/8" SL/P	14	1.75" (44.5)	1.12" (28.4)	0.312" (7.9)	14B	1.75" (44.5)	1.08" (27.4)	0.312" (7.9)	7,500 PSI 520 bar
1/2" L/P	15	1.75" (44.5)	1.00" (25.4)	0.437" (11.1)	15B	1.75" (44.5)	1.00" (25.4)	0.437" (11.1)	5,500 PSI 380 bar

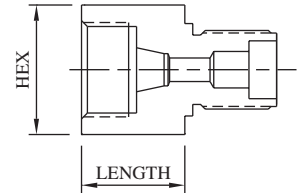

FEMALE M/P CONED AND THREADED TUBE

Connection	For Side Connections				For Bottom Connection				MAWP*
	Suffix	Hex	Length	Port	Suffix	Hex	Length	Port	
3/8" M/P	17	1.75" (44.5)	0.62" (15.7)	0.203" (5.2)	17B	1.75" (44.5)	0.62" (15.7)	0.203" (5.2)	20,000 PSI 1380 bar
9/16" M/P	18	(44.5)	0.94" (23.9)	0.312" (7.9)	18B	1.75" (44.5)	0.94" (23.9)	0.312" (7.9)	20,000 PSI 1380 bar
3/4" M/P	32	1.75" (44.5)	1.36" (34.5)	0.515" (13.1)	32B	1.75" (44.5)	0.89" (22.6)	0.500" (12.7)	20,000 PSI 1380 bar
1" M/P	43	1.75" (44.5)	1.66" (42.2)	0.562" (14.3)	43B	1.75" (44.5)	1.74" (44.2)	0.500" (12.7)	20,000 PSI 1380 bar

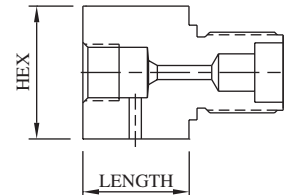

MALE M/P CONED AND THREADED TUBE

Connection	For Side Connections				For Bottom Connection				MAWP*
	Suffix	Hex	Length	Port	Suffix	Hex	Length	Port	
3/8" M/P	10	1.75" (44.5)	2.36" (59.9)	0.203" (5.2)	10B	1.75" (44.5)	2.23" (56.6)	0.203" (5.2)	20,000 PSI 1380 bar
9/16" M/P	11	1.75" (44.5)	2.64" (67.1)	0.312" (7.9)	11B	1.75" (44.5)	2.64" (67.1)	0.312" (7.9)	20,000 PSI 1380 bar
3/4" M/P	37	1.75" (44.5)	2.75" (69.9)	0.437" (11.1)	37B	1.75" (44.5)	2.75" (69.9)	0.437" (11.1)	20,000 PSI 1380 bar
1" M/P	49	1.75" (44.5)	3.21" (81.5)	0.580" (14.7)	49B	1.75" (44.5)	3.21" (81.5)	0.500" (12.7)	20,000 PSI 1380 bar

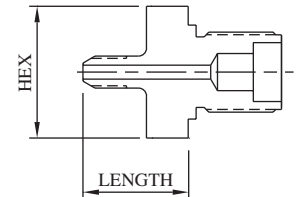

FEMALE H/P CONED AND THREADED TUBE

Connection	For Side Connections				For Bottom Connection				MAWP*
	Suffix	Hex	Length	Port	Suffix	Hex	Length	Port	
3/8" H/P	24	1.75" (44.5)	0.75" (19.1)	0.125" (3.2)	24B	1.75" (44.5)	0.75" (19.1)	0.125" (3.2)	20,000 PSI 1380 bar
9/16" H/P		1.75" (44.5)	1.00" (25.4)	0.187" (4.7)	25B	1.75" (44.5)	1.00" (25.4)	0.187" (4.7)	20,000 PSI 1380 bar

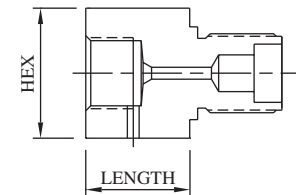

MALE H/P CONED AND THREADED TUBE

Connection	For Side Connections				For Bottom Connection				MAWP*
	Suffix	Hex	Length	Port	Suffix	Hex	Length	Port	
3/8" H/P	30	1.75" (44.5)	2.45" (62.2)	0.125" (3.2)	30B	1.75" (44.5)	2.45" (62.2)	0.125" (3.2)	20,000 PSI 1380 bar
9/16" H/P	42	1.75" (44.5)	2.96" (75.2)	0.187" (4.7)	42B	1.75" (44.5)	2.96" (75.2)	0.187" (4.7)	20,000 PSI 1380 bar

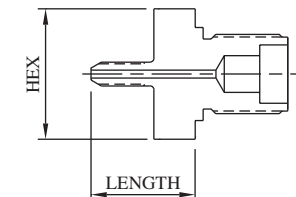

***CAUTION:** The maximum allowable working pressure (MAWP) of the valve shall not exceed the MAWP of the valve series or the selected connection, whichever is less.

All dimensions are for reference only and are subject to change.
Dimensions in parentheses are millimeters (mm).

上海兆帕流体动力有限公司 / Shanghai MPA Fluid Power Co.,Ltd.
Web: www.mpapower.com / E-mail: info@mpapower.com



12,000 PSI (830 BAR) 3-WAY TRUNNION VALVES

**Model No. 3K123
3DVK123**

*MAWP: 12,000 PSI (830 bar)
Port: 0.187" (4.7 mm)
Cv: 0.56

Materials of Construction:

- 316 cold-worked stainless steel body and side adapters
- 17-4PH stem
- PEEK ball seals
- Viton O-rings
- Teflon back-ups

Ordering information and options on page BV-2

Repair Kit P/N's RK-3K123 and RK-3DVK123 contain stem, trunnion, trunnion seals and seal retainers, o-rings, backups, spring washers, and bearing washers

Mounting:

Panel: 1.06" (26.9 mm) dia
0.25" (6.4 mm) max thickness
Top: 1/4"-20 UNC

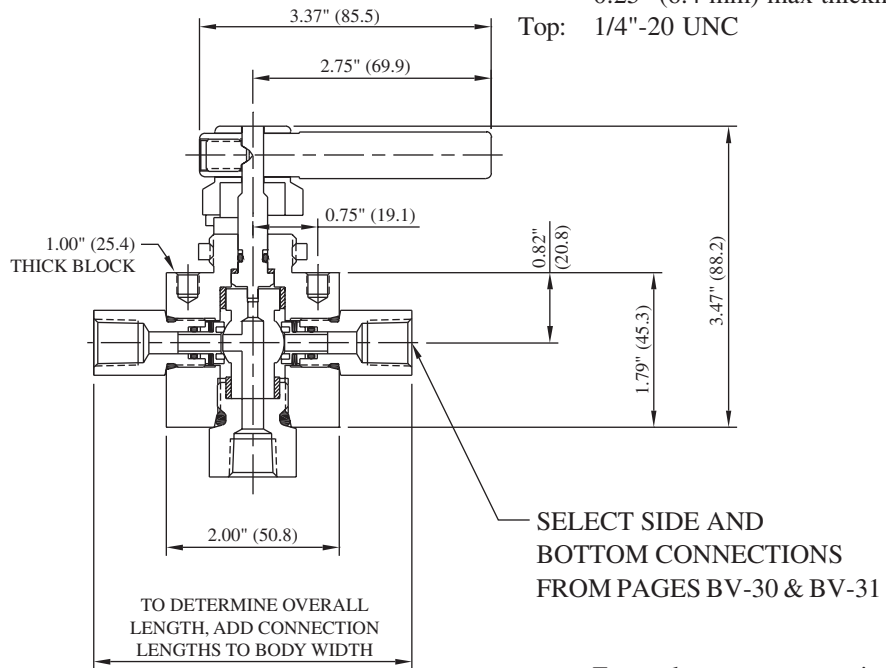

For replacement connections, use prefix number **3-** and suffix number. Ex: 3-20

FEMALE PIPE

Connection	For Side Connections				For Bottom Connection				MAWP*
	Suffix	Hex	Length	Port	Suffix	Hex	Length	Port	
1/8" FNPT	19	0.75" (19.1)	0.60" (15.2)	0.250" (6.4)	19B	1.00" (25.4)	0.63" (16.0)	0.250" (6.4)	15,000 PSI 1030 bar
1/4" FNPT	20	0.75" (19.1)	0.60" (15.2)	0.250" (6.4)	20B	1.00" (25.4)	0.55" (14.0)	0.250" (6.4)	15,000 PSI 1030 bar
3/8" FNPT	21	1.00" (25.4)	1.01" (25.7)	0.250" (6.4)	21B	1.00" (25.4)	1.01" (25.7)	0.250" (6.4)	15,000 PSI 1030 bar
1/2" FNPT	22	1.00" (25.4)	1.01" (25.7)	0.250" (6.4)	22B	1.00" (25.4)	1.16" (29.5)	0.250" (6.4)	15,000 PSI 1030 bar

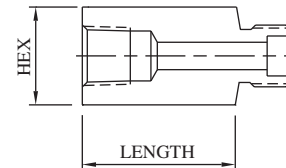

MALE PIPE

Connection	For Side Connections				For Bottom Connection				MAWP*
	Suffix	Hex	Length	Port	Suffix	Hex	Length	Port	
1/8" MNPT	4	0.75" (19.1)	1.01" (25.7)	0.125" (3.2)	4B	1.00" (25.4)	0.93" (23.6)	0.125" (3.2)	15,000 PSI 1030 bar
1/4" MNPT	5	0.75" (19.1)	1.01" (25.7)	0.250" (6.4)	5B	1.00" (25.4)	1.05" (26.7)	0.250" (6.4)	15,000 PSI 1030 bar
3/8" MNPT	6	0.75" (19.1)	1.01" (25.7)	0.250" (6.4)	6B	1.00" (25.4)	1.01" (25.7)	0.250" (6.4)	15,000 PSI 1030 bar
1/2" MNPT	7	1.00" (25.4)	1.26" (32.0)	0.250" (6.4)	7B	1.00" (25.4)	1.29" (32.8)	0.250" (6.4)	15,000 PSI 1030 bar

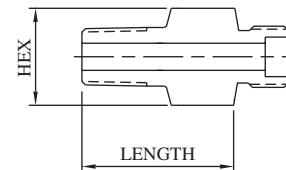

***CAUTION:** The maximum allowable working pressure (MAWP) of the valve shall not exceed the MAWP of the valve series or the selected connection, whichever is less.

All dimensions are for reference only and are subject to change.
Dimensions in parentheses are millimeters (mm).



上海兆帕流体动力有限公司 / Shanghai MPA Fluid Power Co.,Ltd.
Web: www.mpapower.com / E-mail: info@mpapower.com

12,000 PSI (830 BAR) 3-WAY TRUNNION VALVES

Model No. **3K123**
3DVK123

FEMALE SINGLE-FERRULE TUBE

Connection	For Side Connections				For Bottom Connection				MAWP*
	Suffix	Hex	Length	Port	Suffix	Hex	Length	Port	
1/8" L/P	12	0.75" (19.1)	0.78" (19.8)	0.093" (2.4)	12B	1.00" (25.4)	0.55" (14.0)	0.093" (2.4)	15,000 PSI 1030 bar
1/4" SL/P	13	0.75" (19.1)	1.03" (26.2)	0.125" (3.2)	13B	1.00" (25.4)	0.83" (21.0)	0.125" (3.2)	11,500 PSI 790 bar
3/8" SL/P	14	0.75" (19.1)	1.03" (26.2)	0.250" (6.4)	14B	1.00" (25.4)	1.01" (25.7)	0.250" (6.4)	7,500 PSI 520 bar
1/2" L/P	15	1.00" (25.4)	1.03" (26.2)	0.250" (6.4)	15B	1.00" (25.4)	1.01" (25.7)	0.250" (6.4)	5,500 PSI 380 bar

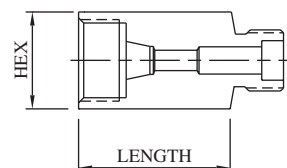

FEMALE M/P CONED AND THREADED TUBE

Connection	For Side Connections				For Bottom Connection				MAWP*
	Suffix	Hex	Length	Port	Suffix	Hex	Length	Port	
1/4" M/P	16	0.75" (19.1)	0.74" (18.8)	0.109" (2.8)	16B	1.00" (25.4)	0.76" (19.3)	0.109" (2.8)	20,000 PSI 1380 bar
3/8" M/P	17	0.75" (19.1)	1.01" (25.7)	0.203" (5.2)	17B	1.00" (25.4)	0.83" (21.0)	0.203" (5.2)	20,000 PSI 1380 bar
9/16" M/P	18	1.00" (25.4)	1.26" (32.0)	0.250" (6.4)	18B	1.00" (25.4)	1.01" (25.7)	0.312" (7.9)	20,000 PSI 1380 bar

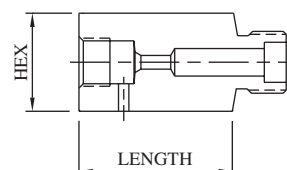

MALE M/P CONED AND THREADED TUBE

Connection	For Side Connections				For Bottom Connection				MAWP*
	Suffix	Hex	Length	Port	Suffix	Hex	Length	Port	
1/4" M/P	8	0.75" (19.1)	1.88" (47.8)	0.109" (2.8)	8B	1.00" (25.4)	1.88" (47.8)	0.109" (2.8)	20,000 PSI 1380 bar
3/8" M/P	10	0.75" (19.1)	2.00" (50.8)	0.203" (5.2)	10B	1.00" (25.4)	2.00" (50.8)	0.203" (5.2)	20,000 PSI 1380 bar
9/16" M/P	11	1.00" (25.4)	2.31" (58.7)	0.250" (6.4)	11B	1.12" (28.4)	2.95" (74.9)	0.312" (7.9)	20,000 PSI 1380 bar

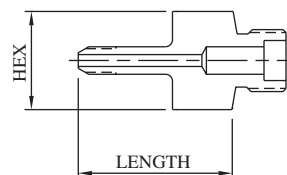

FEMALE H/P CONED AND THREADED TUBE

Connection	For Side Connections				For Bottom Connection				MAWP*
	Suffix	Hex	Length	Port	Suffix	Hex	Length	Port	
1/4" H/P	23	0.75" (19.1)	1.01" (25.7)	0.093" (2.4)	23B	1.00" (25.4)	0.89" (22.6)	0.093" (2.4)	20,000 PSI 1380 bar
3/8" H/P	24	1.00" (25.4)	1.17" (29.7)	0.125" (3.2)	24B	1.00" (25.4)	0.99" (25.1)	0.125" (3.2)	20,000 PSI 1380 bar
9/16" H/P	25	1.37" (34.8)	1.25" (31.8)	0.187" (4.7)	25B	1.37" (34.8)	1.25" (31.8)	0.187" (4.7)	20,000 PSI 1380 bar

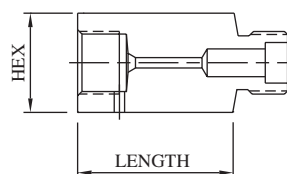

MALE H/P CONED AND THREADED TUBE

Connection	For Side Connections				For Bottom Connection				MAWP*
	Suffix	Hex	Length	Port	Suffix	Hex	Length	Port	
1/4" H/P	9	0.75" (19.1)	1.94" (49.3)	0.083" (2.1)	9B	1.00" (25.4)	2.12" (53.8)	0.083" (2.1)	20,000 PSI 1380 bar
3/8" H/P	30	0.75" (19.1)	2.25" (57.2)	0.125" (3.2)	30B	1.00" (25.4)	2.35" (59.7)	0.125" (3.2)	20,000 PSI 1380 bar
9/16" H/P	42	0.75" (19.1)	2.82" (71.6)	0.187" (4.7)	42B	1.00" (25.4)	2.88" (73.2)	0.187" (4.7)	20,000 PSI 1380 bar

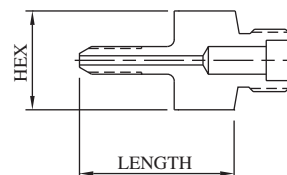

***CAUTION:** The maximum allowable working pressure (MAWP) of the valve shall not exceed the MAWP of the valve series or the selected connection, whichever is less.

All dimensions are for reference only and are subject to change.
Dimensions in parentheses are millimeters (mm).

上海兆帕流体动力有限公司 / Shanghai MPA Fluid Power Co., Ltd.
Web: www.mpapower.com / E-mail: info@mpapower.com



20,000 PSI (1380 BAR) 3-WAY TRUNNION VALVES

**Model No. 3K203
3DVK203**

*MAWP: 20,000 PSI (1380 bar)
Port: 0.187" (4.7 mm)
Cv: 0.56

Materials of Construction:

- 316 cold-worked stainless steel body and side adapters
- 17-4PH stem
- PEEK ball seals
- Viton O-rings
- Teflon back-ups

Ordering information and options on page BV-2

Repair Kit P/N's RK-3K203 and RK-3DVK203 contain stem, trunnion, trunnion seals and seal retainers, o-rings, backups, spring washers, and bearing washers

Mounting:

Panel: 1.06" (26.9 mm) dia
0.25" (6.4 mm) max thickness
Top: 1/4"-20 UNC

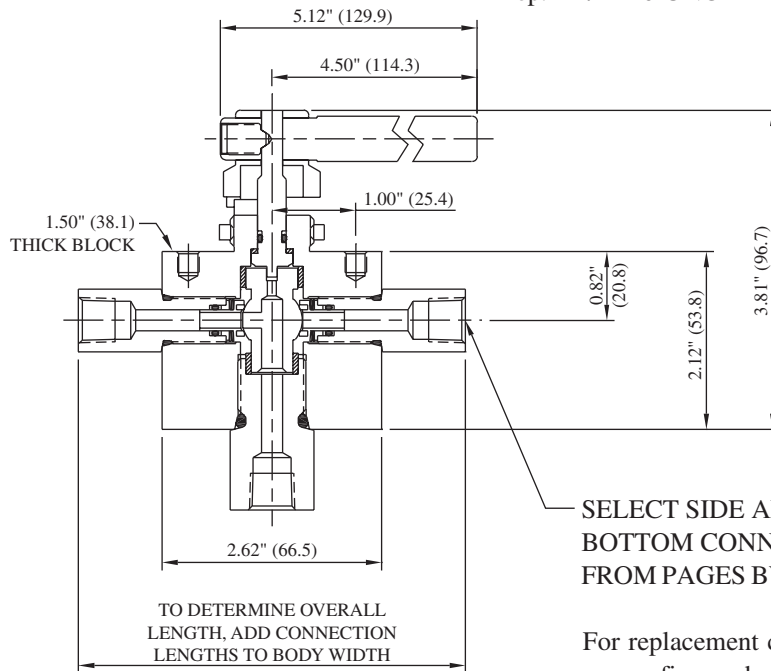

SELECT SIDE AND BOTTOM CONNECTIONS FROM PAGES BV-32 & BV-33

For replacement connections, use prefix number **33-** and suffix number. Ex: 33-20

FEMALE PIPE

Connection	For Side Connections				For Bottom Connection				MAWP*
	Suffix	Hex	Length	Port	Suffix	Hex	Length	Port	
1/8" FNPT	19	0.75" (19.1)	1.00" (25.4)	0.250" (6.4)	19B	1.00" (25.4)	0.50" (12.7)	0.187" (4.7)	15,000 PSI 1030 bar
1/4" FNPT	20	0.75" (19.1)	1.00" (25.4)	0.250" (6.4)	20B	1.00" (25.4)	1.06" (26.9)	0.250" (6.4)	15,000 PSI 1030 bar
3/8" FNPT	21	1.00" (25.4)	1.01" (25.7)	0.250" (6.4)	21B	1.00" (25.4)	1.06" (26.9)	0.250" (6.4)	15,000 PSI 1030 bar
1/2" FNPT	22	1.38" (35.1)	1.13" (28.7)	0.250" (6.4)	22B	1.37" (34.8)	1.12" (28.4)	0.250" (6.4)	15,000 PSI 1030 bar

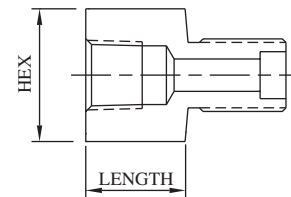

MALE PIPE

Connection	For Side Connections				For Bottom Connection				MAWP*
	Suffix	Hex	Length	Port	Suffix	Hex	Length	Port	
1/8" MNPT	4	0.75" (19.1)	1.11" (28.2)	0.188" (4.8)	4B	1.00" (25.4)	1.08" (27.4)	0.187" (4.7)	15,000 PSI 1030 bar
1/4" MNPT	5	0.75" (19.1)	1.25" (31.8)	0.250" (6.4)	5B	1.00" (25.4)	1.08" (27.4)	0.250" (6.4)	15,000 PSI 1030 bar
3/8" MNPT	6	0.75" (19.1)	1.25" (31.8)	0.250" (6.4)	6B	1.00" (25.4)	1.30" (33.0)	0.250" (6.4)	15,000 PSI 1030 bar
1/2" MNPT	7	1.00" (25.4)	1.60" (40.6)	0.250" (6.4)	7B	1.00" (25.4)	1.52" (38.6)	0.250" (6.4)	15,000 PSI 1030 bar

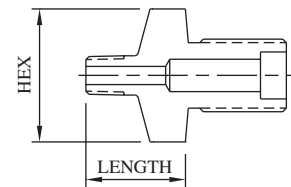

***CAUTION:** The maximum allowable working pressure (MAWP) of the valve shall not exceed the MAWP of the valve series or the selected connection, whichever is less.

All dimensions are for reference only and are subject to change.
Dimensions in parentheses are millimeters (mm).



上海兆帕流体动力有限公司 / Shanghai MPA Fluid Power Co.,Ltd.
Web: www.mpapower.com / E-mail: info@mpapower.com

20,000 PSI (1380 BAR) 3-WAY TRUNNION VALVES

Model No. **3K203**
3DVK203

FEMALE M/P CONED AND THREADED TUBE

Connection	For Side Connections				For Bottom Connection				MAWP*
	Suffix	Hex	Length	Port	Suffix	Hex	Length	Port	
1/4" M/P	16	0.75" (19.1)	1.00" (25.4)	0.125" (3.2)	16B	1.00" (25.4)	1.00" (25.4)	0.125" (3.2)	20,000 PSI 1380 bar
3/8" M/P	17	0.75" (19.1)	1.00" (25.4)	0.203" (5.2)	17B	1.00" (25.4)	1.00" (25.4)	0.203" (5.2)	20,000 PSI 1380 bar
9/16" M/P	18	1.00" (25.4)	1.25" (31.8)	0.250" (6.4)	18B	1.00" (25.4)	1.25" (31.8)	0.312" (7.9)	20,000 PSI 1380 bar

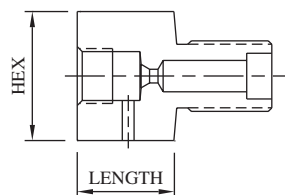

MALE M/P CONED AND THREADED TUBE

Connection	For Side Connections				For Bottom Connection				MAWP*
	Suffix	Hex	Length	Port	Suffix	Hex	Length	Port	
1/4" M/P	8	0.75" (19.1)	1.88" (47.8)	0.109" (2.8)	8B	1.00" (25.4)	1.88" (47.8)	0.109" (2.8)	20,000 PSI 1380 bar
3/8" M/P	10	0.75" (19.1)	1.87" (47.5)	0.203" (5.2)	10B	1.00" (25.4)	2.13" (54.1)	0.203" (5.2)	20,000 PSI 1380 bar
9/16" M/P	11	0.75" (19.1)	2.15" (54.6)	0.203" (5.2)	11B	1.12" (28.4)	2.12" (53.8)	0.312" (7.9)	20,000 PSI 1380 bar

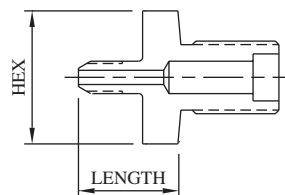

FEMALE H/P CONED AND THREADED TUBE

Connection	For Side Connections				For Bottom Connection				MAWP*
	Suffix	Hex	Length	Port	Suffix	Hex	Length	Port	
1/4" H/P	23	0.75" (19.1)	1.00" (25.4)	0.093" (2.4)	23B	1.00" (25.4)	0.81" (20.6)	0.093" (2.4)	20,000 PSI 1380 bar
3/8" H/P	24	1.00" (25.4)	1.00" (25.4)	0.125" (3.2)	24B	1.00" (25.4)	0.94" (23.9)	0.125" (3.2)	20,000 PSI 1380 bar
9/16" H/P	25	1.38" (35.1)	1.12" (28.4)	0.187" (4.7)	25B	1.38" (35.1)	1.19" (30.2)	0.187" (4.7)	20,000 PSI 1380 bar

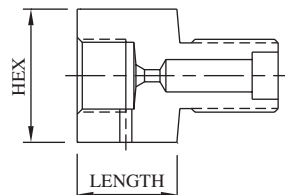

MALE H/P CONED AND THREADED TUBE

Connection	For Side Connections				For Bottom Connection				MAWP*
	Suffix	Hex	Length	Port	Suffix	Hex	Length	Port	
1/4" H/P	9	0.75" (19.1)	1.91" (48.5)	0.083" (2.1)	9B	1.00" (25.4)	1.91" (48.5)	0.083" (2.1)	20,000 PSI 1380 bar
3/8" H/P	30	0.75" (19.1)	2.34" (59.4)	0.125" (3.2)	30B	1.00" (25.4)	2.39" (60.7)	0.125" (3.2)	20,000 PSI 1380 bar
9/16" H/P	42	0.75" (19.1)	2.72" (69.1)	0.187" (4.7)	42B	1.00" (25.4)	2.78" (70.6)	0.187" (4.7)	20,000 PSI 1380 bar

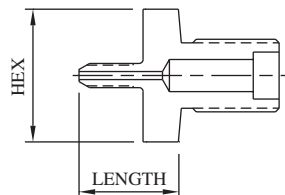

***CAUTION:** The maximum allowable working pressure (MAWP) of the valve shall not exceed the MAWP of the valve series or the selected connection, whichever is less.

All dimensions are for reference only and are subject to change.
Dimensions in parentheses are millimeters (mm).

上海兆帕流体动力有限公司 / Shanghai MPA Fluid Power Co.,Ltd.
Web: www.mpapower.com / E-mail: info@mpapower.com



20,000 PSI (1380 BAR) 3-WAY TRUNNION VALVES

Model No. 3K206
3DVK206

*MAWP: 20,000 PSI (1380 bar)
Port: 0.375" (9.5 mm)
Cv: 2.40

Materials of Construction:

- 316 cold-worked stainless steel body and side adapters
- 17-4PH stem
- PEEK ball seals
- Viton O-rings
- Teflon back-ups

Ordering information and options on page BV-2

Repair Kit P/N's RK-3K206 and RK-3DVK206 contain stem, trunnion, trunnion seals and seal retainers, o-rings, backups, spring washers, and bearing washers

FEMALE PIPE

Connection	For Side Connections				For Bottom Connection				MAWP*
	Suffix	Hex	Length	Port	Suffix	Hex	Length	Port	
1/8" FNPT	19	1.38" (35.1)	0.47" (11.9)	0.339" (8.6)	19B	1.38" (35.1)	0.47" (11.9)	0.339" (8.6)	15,000 PSI 1030 bar
1/4" FNPT	20	1.38" (35.1)	1.00" (25.4)	0.437" (11.1)	20B	1.38" (35.1)	1.06" (26.9)	0.375" (9.5)	15,000 PSI 1030 bar
3/8" FNPT	21	1.38" (35.1)	1.00" (25.4)	0.500" (12.7)	21B	1.38" (35.1)	1.06" (26.9)	0.375" (9.5)	15,000 PSI 1030 bar
1/2" FNPT	22	1.38" (35.1)	1.00" (25.4)	0.500" (12.7)	22B	1.38" (35.1)	1.06" (26.9)	0.375" (9.5)	15,000 PSI 1030 bar
3/4" FNPT	41	1.38" (35.1)	1.10" (27.9)	0.500" (12.7)	41B	1.38" (35.1)	1.17" (29.7)	0.375" (9.5)	10,000 PSI 690 bar
1" FNPT	45	1.75" (44.5)	1.75" (44.5)	0.500" (12.7)	45B	1.75" (44.5)	1.75" (44.5)	0.500" (12.7)	10,000 PSI 690 bar

MALE PIPE

Connection	For Side Connections				For Bottom Connection				MAWP*
	Suffix	Hex	Length	Port	Suffix	Hex	Length	Port	
1/8" MNPT	4	1.38" (35.1)	1.08" (27.4)	0.187" (4.7)	4B	1.38" (35.1)	1.09" (27.7)	0.187" (4.7)	15,000 PSI 1030 bar
1/4" MNPT	5	1.38" (35.1)	1.22" (31.0)	0.250" (6.4)	5B	1.38" (35.1)	1.31" (33.3)	0.250" (6.4)	15,000 PSI 1030 bar
3/8" MNPT	6	1.38" (35.1)	1.23" (31.2)	0.375" (9.5)	6B	1.38" (35.1)	1.43" (36.3)	0.375" (9.5)	15,000 PSI 1030 bar
1/2" MNPT	7	1.38" (35.1)	1.59" (40.4)	0.375" (9.5)	7B	1.38" (35.1)	1.63" (41.4)	0.375" (9.5)	15,000 PSI 1030 bar
3/4" MNPT	55	1.38" (35.1)	1.62" (41.1)	0.500" (12.7)	55B	1.38" (35.1)	1.65" (41.9)	0.375" (9.5)	10,000 PSI 690 bar
1" MNPT	56	1.50" (38.1)	1.87" (47.5)	0.500" (12.7)	56B	1.50" (38.1)	1.90" (48.3)	0.375" (9.5)	10,000 PSI 690 bar

Mounting:

Panel: 1.06" (26.9 mm) dia
0.25" (6.3 mm) max thickness
Side: 0.28" (7.1 mm) dia

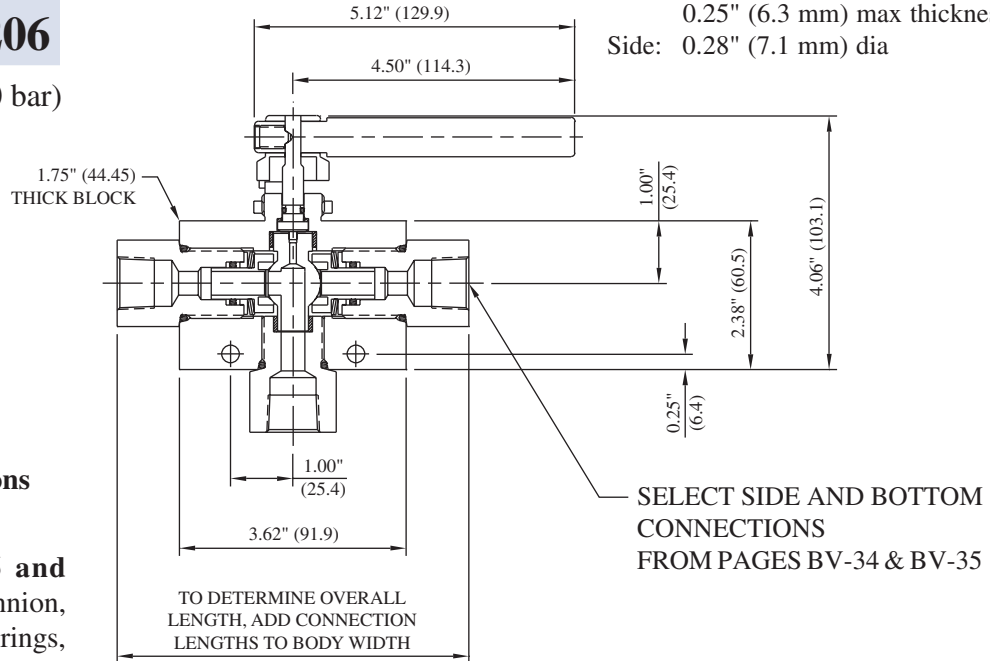

For replacement connections, use prefix number **36-** and suffix number. Ex: 36-20

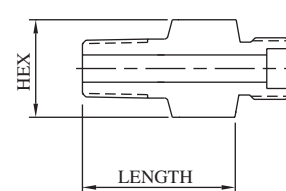
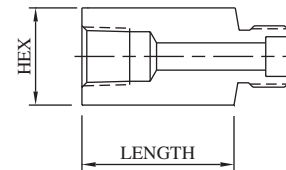

***CAUTION:** The maximum allowable working pressure (MAWP) of the valve shall not exceed the MAWP of the valve series or the selected connection, whichever is less.

All dimensions are for reference only and are subject to change.
Dimensions in parentheses are millimeters (mm).



上海兆帕流体动力有限公司 / Shanghai MPA Fluid Power Co.,Ltd.
Web: www.mpapower.com / E-mail: info@mpapower.com

20,000 PSI (1380 BAR) 3-WAY TRUNNION VALVES

Model No. **3K206**
3DVK206

FEMALE SINGLE-FERRULE TUBE

Connection	For Side Connections				For Bottom Connection				MAWP*
	Suffix	Hex	Length	Port	Suffix	Hex	Length	Port	
1/4" SL/P	13	1.38" (35.1)	0.64" (16.3)	0.187" (4.7)	13B	1.38" (35.1)	0.66" (16.8)	0.187" (4.7)	11,500 PSI 790 bar
3/8" SL/P	14	1.38" (35.1)	0.75" (19.1)	0.312" (7.9)	14B	1.38" (35.1)	0.75" (19.1)	0.312" (7.9)	7,500 PSI 520 bar
1/2" L/P	15	1.38" (35.1)	1.06" (26.9)	0.437" (11.1)	15B	1.38" (35.1)	1.06" (26.9)	0.375" (9.5)	5,500 PSI 380 bar

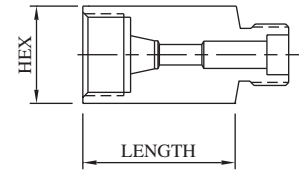

FEMALE M/P CONED AND THREADED TUBE

Connection	For Side Connections				For Bottom Connection				MAWP*
	Suffix	Hex	Length	Port	Suffix	Hex	Length	Port	
1/4" M/P	16	1.38" (35.1)	0.65" (16.5)	0.109" (2.8)	16B	1.38" (35.1)	0.72" (18.3)	0.109" (2.8)	20,000 PSI 1380 bar
3/8" M/P	17	1.38" (35.1)	1.06" (26.9)	0.203" (5.2)	17B	1.38" (35.1)	1.06" (26.9)	0.203" (5.2)	20,000 PSI 1380 bar
9/16" M/P	18	1.38" (35.1)	1.31" (33.3)	0.312" (7.9)	18B	1.38" (35.1)	1.06" (26.9)	0.312" (7.9)	20,000 PSI 1380 bar
3/4" M/P	32	1.38" (35.1)	1.52" (38.6)	0.437" (11.1)	32B	1.38" (35.1)	1.18" (30.0)	0.375" (9.5)	20,000 PSI 1380 bar
1" M/P	43	1.75" (44.5)	1.91" (48.5)	0.500" (12.7)	43B	1.75" (44.5)	1.99" (50.5)	0.375" (9.5)	20,000 PSI 1380 bar

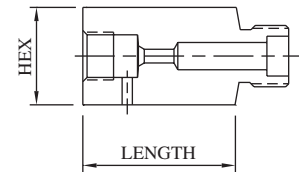

MALE M/P CONED AND THREADED TUBE

Connection	For Side Connections				For Bottom Connection				MAWP*
	Suffix	Hex	Length	Port	Suffix	Hex	Length	Port	
1/4" M/P	8	1.38" (35.1)	1.91" (48.5)	0.109" (2.8)	8B	1.38" (35.1)	1.93" (49.0)	0.109" (2.8)	20,000 PSI 1380 bar
3/8" M/P	10	1.38" (35.1)	1.87" (47.5)	0.203" (5.2)	10B	1.38" (35.1)	2.17" (55.1)	0.203" (5.2)	20,000 PSI 1380 bar
9/16" M/P	11	1.38" (35.1)	3.21" (81.5)	0.312" (7.9)	11B	1.38" (35.1)	2.18" (55.4)	0.312" (7.9)	20,000 PSI 1380 bar
3/4" M/P	37	1.38" (35.1)	3.54" (89.9)	0.437" (11.1)	37B	1.38" (35.1)	5.06" (128.5)	0.437" (11.1)	20,000 PSI 1380 bar
1" M/P	49	1.38" (35.1)	3.20" (81.3)	0.500" (12.7)	49B	1.38" (35.1)	3.25" (82.6)	0.500" (12.7)	20,000 PSI 1380 bar

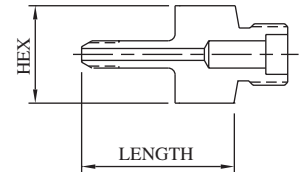

FEMALE H/P CONED AND THREADED TUBE

Connection	For Side Connections				For Bottom Connection				MAWP*
	Suffix	Hex	Length	Port	Suffix	Hex	Length	Port	
1/4" H/P	23	1.38" (35.1)	0.58" (14.7)	0.093" (2.4)	23B	1.38" (35.1)	0.60" (15.2)	0.093" (2.4)	20,000 PSI 1380 bar
3/8" H/P	24	1.38" (35.1)	0.89" (22.6)	0.125" (3.2)	24B	1.38" (35.1)	0.91" (23.1)	0.125" (3.2)	20,000 PSI 1380 bar
9/16" H/P	25	1.50" (38.1)	0.98" (24.9)	0.187" (4.7)	25B	1.50" (38.1)	1.02" (25.9)	0.187" (4.7)	20,000 PSI 1380 bar

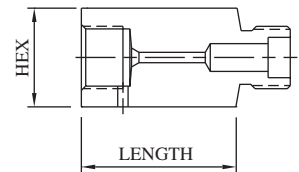

MALE H/P CONED AND THREADED TUBE

Connection	For Side Connections				For Bottom Connection				MAWP*
	Suffix	Hex	Length	Port	Suffix	Hex	Length	Port	
1/4" H/P	9	1.38" (35.1)	2.16" (54.9)	0.083" (2.1)	9B	1.38" (35.1)	2.19" (55.6)	0.083" (2.1)	20,000 PSI 1380 bar
3/8" H/P	30	1.38" (35.1)	2.40" (61.0)	0.125" (3.2)	30B	1.38" (35.1)	2.42" (61.5)	0.125" (3.2)	20,000 PSI 1380 bar
9/16" H/P	42	1.38" (35.1)	2.89" (73.4)	0.187" (4.7)	42B	1.38" (35.1)	2.92" (74.2)	0.187" (4.7)	20,000 PSI 1380 bar

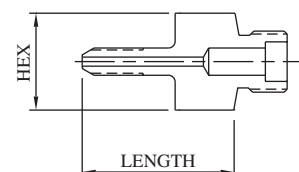

***CAUTION:** The maximum allowable working pressure (MAWP) of the valve shall not exceed the MAWP of the valve series or the selected connection, whichever is less.

All dimensions are for reference only and are subject to change.
Dimensions in parentheses are millimeters (mm).

上海兆帕流体动力有限公司 / Shanghai MPA Fluid Power Co.,Ltd.
Web: www.mpapower.com / E-mail: info@mpapower.com



10,000 PSI (690 BAR) 4-WAY TRUNNION VALVES

Model No. 4K103

*MAWP: 10,000 PSI (690 bar)
 Port: 0.187" (4.7 mm)
 Cv: 0.56

Materials of Construction:

- 316 cold-worked stainless steel body and side adapters
- 17-4PH stem
- PEEK ball seals
- Viton O-rings
- Teflon back-ups

Ordering information and options on page BV-2

Repair Kit P/N RK-4K103 contains stem, trunnion, trunnion seals and seal retainers, o-rings, backups, spring washers, and bearing washers

Mounting:

Panel: 1.06" (26.9 mm) dia
 0.25" (6.4 mm) max thickness
 Top: 1/4"-20 UNC

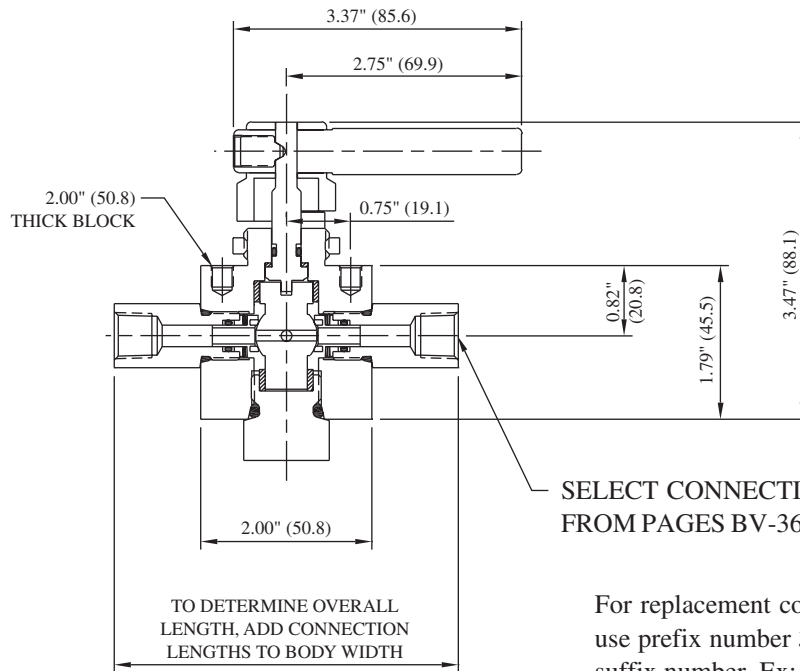

FEMALE PIPE

Connection	Suffix	Hex	Length	Port	MAWP*
1/8" FNPT	19	0.75" (19.1)	0.60" (15.2)	0.250" (6.4)	15,000 PSI 1030 bar
1/4" FNPT	20	0.75" (19.1)	0.60" (15.2)	0.250" (6.4)	15,000 PSI 1030 bar
3/8" FNPT	21	1.00" (25.4)	1.01" (25.7)	0.250" (6.4)	15,000 PSI 1030 bar
1/2" FNPT	22	1.00" (25.4)	1.01" (25.7)	0.250" (6.4)	15,000 PSI 1030 bar

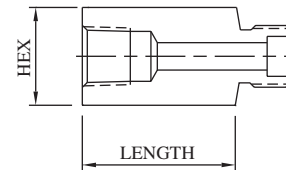

MALE PIPE

Connection	Suffix	Hex	Length	Port	MAWP*
1/8" MNPT	4	0.75" (19.1)	1.01" (25.7)	0.125" (3.2)	15,000 PSI 1030 bar
1/4" MNPT	5	0.75" (19.1)	1.01" (25.7)	0.250" (6.4)	15,000 PSI 1030 bar
3/8" MNPT	6	0.75" (19.1)	1.01" (25.7)	0.250" (6.4)	15,000 PSI 1030 bar
1/2" MNPT	7	1.00" (25.4)	1.26" (32.0)	0.250" (6.4)	15,000 PSI 1030 bar

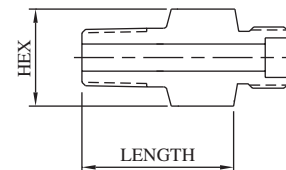

***CAUTION:** The maximum allowable working pressure (MAWP) of the valve shall not exceed the MAWP of the valve series or the selected connection, whichever is less.

All dimensions are for reference only and are subject to change.
 Dimensions in parentheses are millimeters (mm).



上海兆帕流体动力有限公司 / Shanghai MPA Fluid Power Co.,Ltd.
 Web: www.mpapower.com / E-mail: info@mpapower.com

10,000 PSI (690 BAR) 4-WAY TRUNNION VALVES

Model No. **4K103**

FEMALE SINGLE-FERRULE TUBE

Connection	Suffix	Hex	Length	Port	MAWP*
1/8" L/P	12	0.75" (19.1)	0.78" (19.8)	0.093" (2.4)	15,000 PSI 1030 bar
1/4" SL/P	13	0.75" (19.1)	1.03" (26.2)	0.125" (3.2)	11,500 PSI 790 bar
3/8" SL/P	14	0.75" (19.1)	1.03" (26.2)	0.250" (6.4)	7,500 PSI 520 bar
1/2" L/P	15	1.00" (25.4)	1.03" (26.2)	0.250" (6.4)	5,500 PSI 380 bar

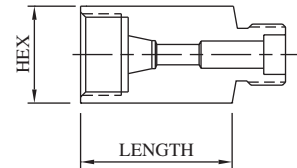

FEMALE M/P CONED AND THREADED TUBE

Connection	Suffix	Hex	Length	Port	MAWP*
1/4" M/P	16	0.75" (19.1)	0.74" (18.8)	0.109" (2.8)	20,000 PSI 1380 bar
3/8" M/P	17	0.75" (19.1)	1.01" (25.7)	0.203" (5.2)	20,000 PSI 1380 bar
9/16" M/P	18	1.00" (25.4)	1.26" (32.0)	0.250" (6.4)	20,000 PSI 1380 bar

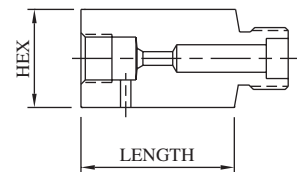

MALE M/P CONED AND THREADED TUBE

Connection	Suffix	Hex	Length	Port	MAWP*
1/4" M/P	8	0.75" (19.1)	1.88" (47.8)	0.109" (2.8)	20,000 PSI 1380 bar
3/8" M/P	10	0.75" (19.1)	2.00" (50.8)	0.203" (5.2)	20,000 PSI 1380 bar
9/16" M/P	11	1.00" (25.4)	2.31" (58.7)	0.250" (6.4)	20,000 PSI 1380 bar

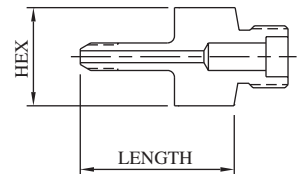

FEMALE H/P CONED AND THREADED TUBE

Connection	Suffix	Hex	Length	Port	MAWP*
1/4" H/P	23	0.75" (19.1)	1.01" (25.7)	0.093" (2.4)	20,000 PSI 1380 bar
3/8" H/P	24	1.00" (25.4)	1.17" (29.7)	0.125" (3.2)	20,000 PSI 1380 bar
9/16" H/P	25	1.37" (34.8)	1.25" (31.8)	0.187" (4.7)	20,000 PSI 1380 bar

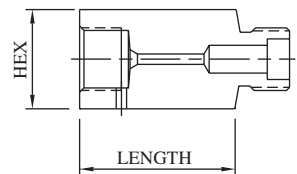

MALE H/P CONED AND THREADED TUBE

Connection	Suffix	Hex	Length	Port	MAWP*
1/4" H/P	9	0.75" (19.1)	1.94" (49.3)	0.083" (2.1)	20,000 PSI 1380 bar
3/8" H/P	30	0.75" (19.1)	2.25" (57.2)	0.125" (3.2)	20,000 PSI 1380 bar
9/16" H/P	42	0.75" (19.1)	2.82" (71.6)	0.187" (4.7)	20,000 PSI 1380 bar

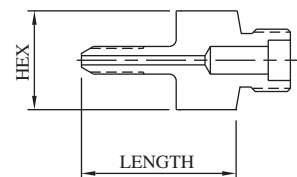

***CAUTION:** The maximum allowable working pressure (MAWP) of the valve shall not exceed the MAWP of the valve series or the selected connection, whichever is less.

All dimensions are for reference only and are subject to change.
Dimensions in parentheses are millimeters (mm).

上海兆帕流体动力有限公司 / Shanghai MPA Fluid Power Co.,Ltd.
Web: www.mpapower.com / E-mail: info@mpapower.com



10,000 PSI (690 BAR) 4-WAY TRUNNION VALVES

Model No. 4K106

*MAWP: 10,000 PSI (690 bar)
 Port: 0.375" (9.5 mm)
 Cv: 2.40

Materials of Construction:

- 316 cold-worked stainless steel body and side adapters
- 17-4PH stem
- PEEK ball seals
- Viton O-rings
- Teflon back-ups

Ordering information and options on page BV-2

Repair Kit P/N RK-4K106 contains stem, trunnion, trunnion seals and seal retainers, o-rings, backups, spring washers, and bearing washers

Mounting:

Panel: 1.28" (32.5 mm) dia
 0.43" (11.0 mm) max thickness
 Side: 0.28" (7.1 mm) dia

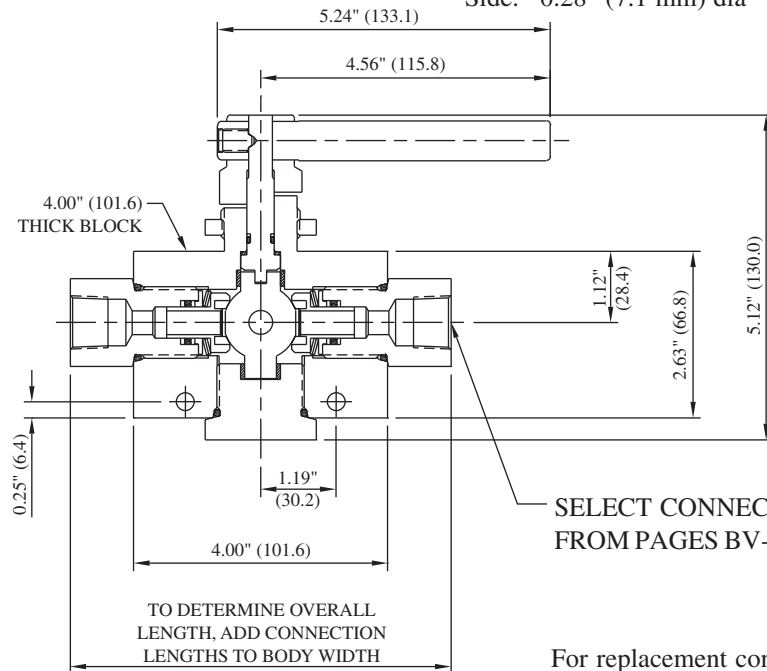

For replacement connections, use prefix number **36-** and suffix number. Ex: 36-20

FEMALE PIPE

Connection	Suffix	Hex	Length	Port	MAWP*
1/8" FNPT	19	1.38" (35.1)	0.47" (11.9)	0.339" (8.6)	15,000 PSI 1030 bar
1/4" FNPT	20	1.38" (35.1)	1.00" (25.4)	0.437" (11.1)	15,000 PSI 1030 bar
3/8" FNPT	21	1.38" (35.1)	1.00" (25.4)	0.500" (12.7)	15,000 PSI 1030 bar
1/2" FNPT	22	1.38" (35.1)	1.00" (25.4)	0.500" (12.7)	15,000 PSI 1030 bar
3/4" FNPT	41	1.38" (35.1)	1.10" (27.9)	0.500" (12.7)	10,000 PSI 690 bar
1" FNPT	45	1.75" (44.5)	1.75" (44.5)	0.500" (12.7)	10,000 PSI 690 bar

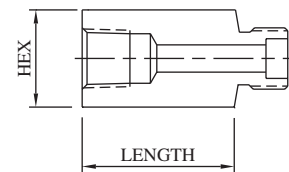

MALE PIPE

Connection	Suffix	Hex	Length	Port	MAWP*
1/8" MNPT	4	1.38" (35.1)	1.08" (27.4)	0.187" (4.7)	15,000 PSI 1030 bar
1/4" MNPT	5	1.38" (35.1)	1.22" (31.0)	0.250" (6.4)	15,000 PSI 1030 bar
3/8" MNPT	6	1.38" (35.1)	1.23" (31.2)	0.375" (9.5)	15,000 PSI 1030 bar
1/2" MNPT	7	1.38" (35.1)	1.59" (40.4)	0.375" (9.5)	15,000 PSI 1030 bar
3/4" MNPT	55	1.38" (35.1)	1.62" (41.1)	0.500" (12.7)	10,000 PSI 690 bar
1" MNPT	56	1.50" (38.1)	1.87" (47.5)	0.500" (12.7)	10,000 PSI 690 bar

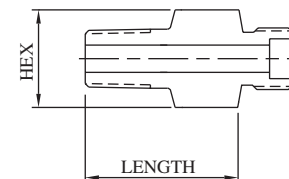

***CAUTION:** The maximum allowable working pressure (MAWP) of the valve shall not exceed the MAWP of the valve series or the selected connection, whichever is less.

All dimensions are for reference only and are subject to change.
 Dimensions in parentheses are millimeters (mm).



上海兆帕流体动力有限公司 / Shanghai MPA Fluid Power Co.,Ltd.
 Web: www.mpapower.com / E-mail: info@mpapower.com

10,000 PSI (690 BAR) 4-WAY TRUNNION VALVES

Model No. 4K106

FEMALE SINGLE-FERRULE TUBE

Connection	Suffix	Hex	Length	Port	MAWP*
1/4" SL/P	13	1.38" (35.1)	0.64" (16.3)	0.187" (4.7)	11,500 PSI 790 bar
3/8" SL/P	14	1.38" (35.1)	0.75" (19.1)	0.312" (7.9)	7,500 PSI 520 bar
1/2" L/P	15	1.38" (35.1)	1.06" (26.9)	0.437" (11.1)	5,500 PSI 380 bar

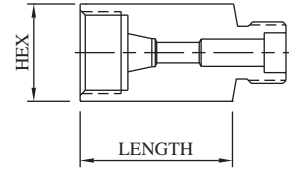

FEMALE M/P CONED AND THREADED TUBE

Connection	Suffix	Hex	Length	Port	MAWP*
1/4" M/P	16	1.38" (35.1)	0.65" (16.5)	0.109" (2.8)	20,000 PSI 1380 bar
3/8" M/P	17	1.38" (35.1)	1.06" (26.9)	0.203" (5.2)	20,000 PSI 1380 bar
9/16" M/P	18	1.38" (35.1)	1.31" (33.3)	0.312" (7.9)	20,000 PSI 1380 bar
3/4" M/P	32	1.38" (35.1)	1.52" (38.6)	0.437" (11.1)	20,000 PSI 1380 bar
1" M/P	43	1.75" (44.5)	1.91" (48.5)	0.500" (12.7)	20,000 PSI 1380 bar

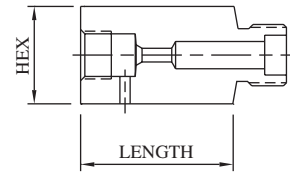

MALE M/P CONED AND THREADED TUBE

Connection	Suffix	Hex	Length	Port	MAWP*
1/4" M/P	8	1.38" (35.1)	1.91" (48.5)	0.109" (2.8)	20,000 PSI 1380 bar
3/8" M/P	10	1.38" (35.1)	1.87" (47.5)	0.203" (5.2)	20,000 PSI 1380 bar
9/16" M/P	11	1.38" (35.1)	3.21" (81.5)	0.312" (7.9)	20,000 PSI 1380 bar
3/4" M/P	37	1.38" (35.1)	3.54" (89.9)	0.437" (11.1)	20,000 PSI 1380 bar
1" M/P	49	1.38" (35.1)	3.20" (81.3)	0.500" (12.7)	20,000 PSI 1380 bar

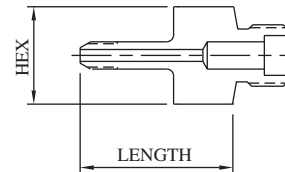

FEMALE H/P CONED AND THREADED TUBE

Connection	Suffix	Hex	Length	Port	MAWP*
1/4" H/P	23	1.38" (35.1)	0.58" (14.7)	0.093" (2.4)	20,000 PSI 1380 bar
3/8" H/P	24	1.38" (35.1)	0.89" (22.6)	0.125" (3.2)	20,000 PSI 1380 bar
9/16" H/P	25	1.50" (38.1)	0.98" (24.9)	0.187" (4.7)	20,000 PSI 1380 bar

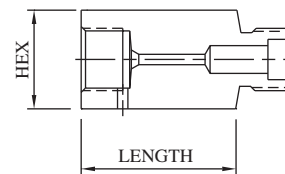

MALE H/P CONED AND THREADED TUBE

Connection	Suffix	Hex	Length	Port	MAWP*
1/4" H/P	9	1.38" (35.1)	2.16" (54.9)	0.083" (2.1)	20,000 PSI 1380 bar
3/8" H/P	30	1.38" (35.1)	2.40" (61.0)	0.125" (3.2)	20,000 PSI 1380 bar
9/16" H/P	42	1.38" (35.1)	2.89" (73.4)	0.187" (4.7)	20,000 PSI 1380 bar

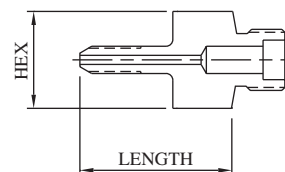

***CAUTION:** The maximum allowable working pressure (MAWP) of the valve shall not exceed the MAWP of the valve series or the selected connection, whichever is less.

All dimensions are for reference only and are subject to change.
Dimensions in parentheses are millimeters (mm).

上海兆帕流体动力有限公司 / Shanghai MPA Fluid Power Co., Ltd.
Web: www.mpapower.com / E-mail: info@mpapower.com

BuTech
MILTON ROY

10,000 PSI (690 BAR) 5-WAY TRUNNION VALVES

Model No. 5K103

*MAWP: 10,000 PSI (690 bar)
 Port: 0.187" (4.7 mm)
 Cv: 0.56

Materials of Construction:

- 316 cold-worked stainless steel body and side adapters
- 17-4PH stem
- PEEK ball seals
- Viton O-rings
- Teflon back-ups

Ordering information and options on page BV-2

Repair Kit P/N RK-5K103 contains stem, trunnion, trunnion seals and seal retainers, o-rings, backups, spring washers, and bearing washers

Mounting:

Panel: 1.06" (26.9 mm) dia
 0.25" (6.4 mm) max thickness
 Top: 1/4"-20 UNC

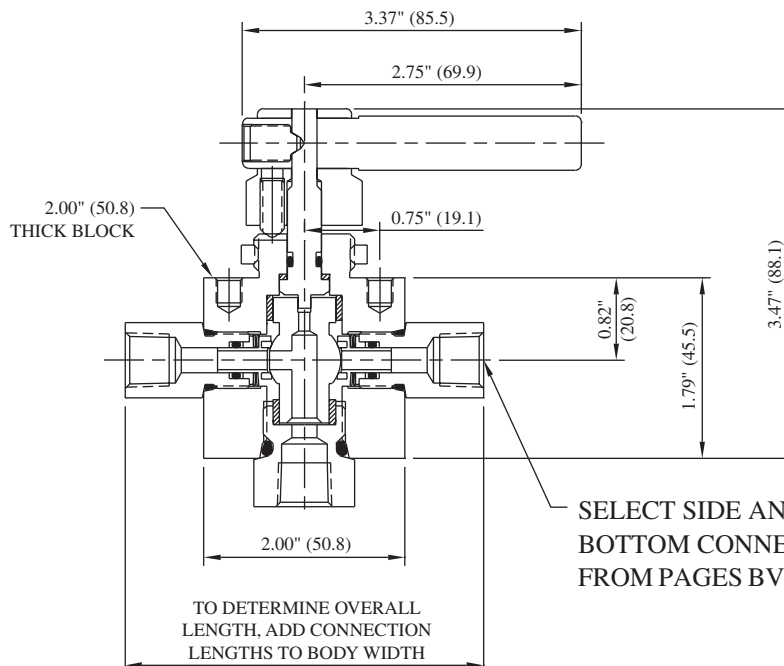

SELECT SIDE AND BOTTOM CONNECTIONS FROM PAGES BV-40 & BV-41

For replacement connections, use prefix number **3-** and suffix number. Ex: 3-20

FEMALE PIPE

Connection	For Side Connections				For Bottom Connection				MAWP*
	Suffix	Hex	Length	Port	Suffix	Hex	Length	Port	
1/8" FNPT	19	0.75" (19.1)	0.60" (15.2)	0.250" (6.4)	19B	1.00" (25.4)	0.63" (16.0)	0.250" (6.4)	15,000 PSI 1030 bar
1/4" FNPT	20	0.75" (19.1)	0.60" (15.2)	0.250" (6.4)	20B	1.00" (25.4)	0.55" (14.0)	0.250" (6.4)	15,000 PSI 1030 bar
3/8" FNPT	21	1.00" (25.4)	1.01" (25.7)	0.250" (6.4)	21B	1.00" (25.4)	1.01" (25.7)	0.250" (6.4)	15,000 PSI 1030 bar
1/2" FNPT	22	1.00" (25.4)	1.01" (25.7)	0.250" (6.4)	22B	1.00" (25.4)	1.16" (29.5)	0.250" (6.4)	15,000 PSI 1030 bar

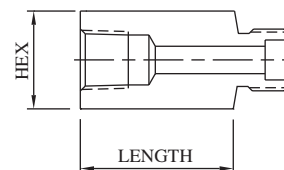

MALE PIPE

Connection	For Side Connections				For Bottom Connection				MAWP*
	Suffix	Hex	Length	Port	Suffix	Hex	Length	Port	
1/8" MNPT	4	0.75" (19.1)	1.01" (25.7)	0.125" (3.2)	4B	1.00" (25.4)	0.93" (23.6)	0.125" (3.2)	15,000 PSI 1030 bar
1/4" MNPT	5	0.75" (19.1)	1.01" (25.7)	0.250" (6.4)	5B	1.00" (25.4)	1.05" (26.7)	0.250" (6.4)	15,000 PSI 1030 bar
3/8" MNPT	6	0.75" (19.1)	1.01" (25.7)	0.250" (6.4)	6B	1.00" (25.4)	1.01" (25.7)	0.250" (6.4)	15,000 PSI 1030 bar
1/2" MNPT	7	1.00" (25.4)	1.26" (32.0)	0.250" (6.4)	7B	1.00" (25.4)	1.29" (32.8)	0.250" (6.4)	15,000 PSI 1030 bar

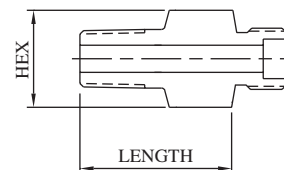

***CAUTION:** The maximum allowable working pressure (MAWP) of the valve shall not exceed the MAWP of the valve series or the selected connection, whichever is less.

All dimensions are for reference only and are subject to change.
 Dimensions in parentheses are millimeters (mm).



上海兆帕流体动力有限公司 / Shanghai MPA Fluid Power Co.,Ltd.
 Web: www.mpapower.com / E-mail: info@mpapower.com

10,000 PSI (690 BAR) 5-WAY TRUNNION VALVES

Model No. **5K103**

FEMALE SINGLE-FERRULE TUBE

Connection	For Side Connections				For Bottom Connection				MAWP*
	Suffix	Hex	Length	Port	Suffix	Hex	Length	Port	
1/8" L/P	12	0.75" (19.1)	0.78" (19.8)	0.093" (2.4)	12B	1.00" (25.4)	0.55" (14.0)	0.093" (2.4)	15,000 PSI 1030 bar
1/4" SL/P	13	0.75" (19.1)	1.03" (26.2)	0.125" (3.2)	13B	1.00" (25.4)	0.83" (21.0)	0.125" (3.2)	11,500 PSI 790 bar
3/8" SL/P	14	0.75" (19.1)	1.03" (26.2)	0.250" (6.4)	14B	1.00" (25.4)	1.01" (25.7)	0.250" (6.4)	7,500 PSI 520 bar
1/2" L/P	15	1.00" (25.4)	1.03" (26.2)	0.250" (6.4)	15B	1.00" (25.4)	1.01" (25.7)	0.250" (6.4)	5,500 PSI 380 bar

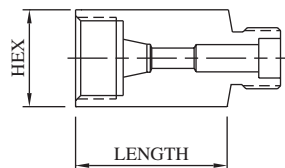

FEMALE M/P CONED AND THREADED TUBE

Connection	For Side Connections				For Bottom Connection				MAWP*
	Suffix	Hex	Length	Port	Suffix	Hex	Length	Port	
1/4" M/P	16	0.75" (19.1)	0.74" (18.8)	0.109" (2.8)	16B	1.00" (25.4)	0.76" (19.3)	0.109" (2.8)	20,000 PSI 1380 bar
3/8" M/P	17	0.75" (19.1)	1.01" (25.7)	0.203" (5.2)	17B	1.00" (25.4)	0.83" (21.0)	0.203" (5.2)	20,000 PSI 1380 bar
9/16" M/P	18	1.00" (25.4)	1.26" (32.0)	0.250" (6.4)	18B	1.00" (25.4)	1.01" (25.7)	0.312" (7.9)	20,000 PSI 1380 bar

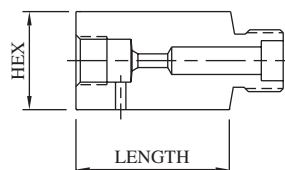

MALE M/P CONED AND THREADED TUBE

Connection	For Side Connections				For Bottom Connection				MAWP*
	Suffix	Hex	Length	Port	Suffix	Hex	Length	Port	
1/4" M/P	8	0.75" (19.1)	1.88" (47.8)	0.109" (2.8)	8B	1.00" (25.4)	1.88" (47.8)	0.109" (2.8)	20,000 PSI 1380 bar
3/8" M/P	10	0.75" (19.1)	2.00" (50.8)	0.203" (5.2)	10B	1.00" (25.4)	2.00" (50.8)	0.203" (5.2)	20,000 PSI 1380 bar
9/16" M/P	11	1.00" (25.4)	2.31" (58.7)	0.250" (6.4)	11B	1.12" (28.4)	2.95" (74.9)	0.312" (7.9)	20,000 PSI 1380 bar

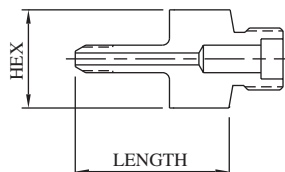

FEMALE H/P CONED AND THREADED TUBE

Connection	For Side Connections				For Bottom Connection				MAWP*
	Suffix	Hex	Length	Port	Suffix	Hex	Length	Port	
1/4" H/P	23	0.75" (19.1)	1.01" (25.7)	0.093" (2.4)	23B	1.00" (25.4)	0.89" (22.6)	0.093" (2.4)	20,000 PSI 1380 bar
3/8" H/P	24	1.00" (25.4)	1.17" (29.7)	0.125" (3.2)	24B	1.00" (25.4)	0.99" (25.1)	0.125" (3.2)	20,000 PSI 1380 bar
9/16" H/P	25	1.37" (34.8)	1.25" (31.8)	0.187" (4.7)	25B	1.37" (34.8)	1.25" (31.8)	0.187" (4.7)	20,000 PSI 1380 bar

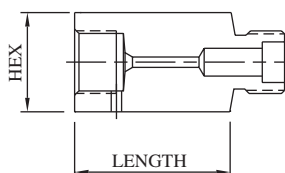

MALE H/P CONED AND THREADED TUBE

Connection	For Side Connections				For Bottom Connection				MAWP*
	Suffix	Hex	Length	Port	Suffix	Hex	Length	Port	
1/4" H/P	9	0.75" (19.1)	1.94" (49.3)	0.083" (2.1)	9B	1.00" (25.4)	2.12" (53.8)	0.083" (2.1)	20,000 PSI 1380 bar
3/8" H/P	30	0.75" (19.1)	2.25" (57.2)	0.125" (3.2)	30B	1.00" (25.4)	2.35" (59.7)	0.125" (3.2)	20,000 PSI 1380 bar
9/16" H/P	42	0.75" (19.1)	2.82" (71.6)	0.187" (4.7)	42B	1.00" (25.4)	2.88" (73.2)	0.187" (4.7)	20,000 PSI 1380 bar

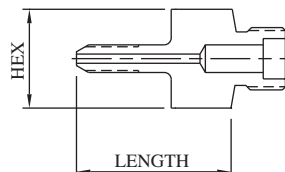

***CAUTION:** The maximum allowable working pressure (MAWP) of the valve shall not exceed the MAWP of the valve series or the selected connection, whichever is less.

All dimensions are for reference only and are subject to change.
Dimensions in parentheses are millimeters (mm).

上海兆帕流体动力有限公司 / Shanghai MPA Fluid Power Co.,Ltd.
Web: www.mpapower.com / E-mail: info@mpapower.com



10,000 PSI (690 BAR) 5-WAY TRUNNION VALVES

Model No. 5K106

*MAWP: 10,000 PSI (690 bar)
 Port: 0.375" (9.5 mm)
 Cv: 2.40

Materials of Construction:

- 316 cold-worked stainless steel body and side adapters
- 17-4PH stem
- PEEK ball seals
- Viton O-rings
- Teflon back-ups

Ordering information and options on page BV-2

Repair Kit P/N RK-5K106 contains stem, trunnion, trunnion seals and seal retainers, o-rings, backups, spring washers, and bearing washers

Mounting:

Panel: 1.28" (32.5 mm) dia
 0.43" (11.0 mm) max thickness
 Side: 0.28" (7.1 mm) dia

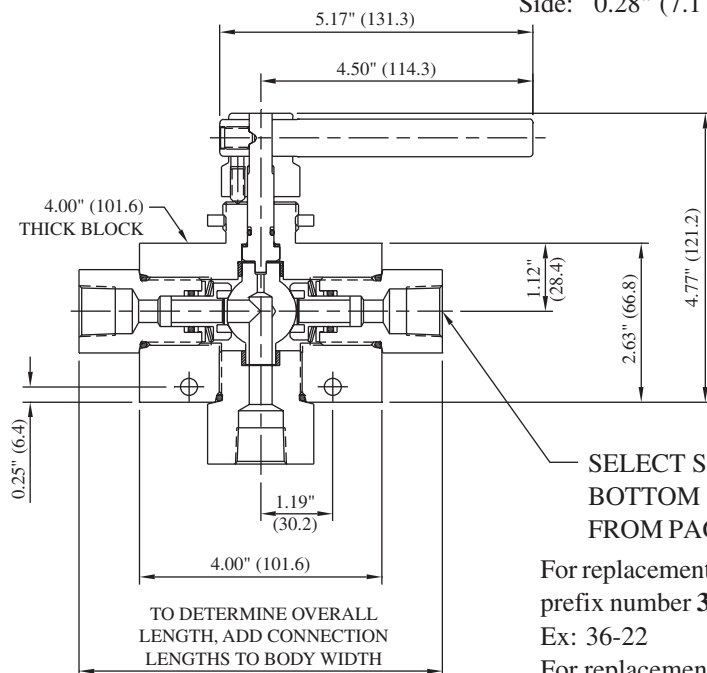

SELECT SIDE AND BOTTOM CONNECTIONS FROM PAGES BV-42 & BV-43

For replacement side connections, use prefix number **36-** and suffix number. Ex: 36-22
 For replacement bottom connections, use prefix number **46-** and suffix number. Ex: 46-22B

FEMALE PIPE

Connection	For Side Connections				For Bottom Connection				MAWP*
	Suffix	Hex	Length	Port	Suffix	Hex	Length	Port	
1/8" FNPT	19	1.38" (35.1)	0.47" (11.9)	0.339" (8.6)	19B	1.75" (44.5)	0.47" (11.9)	0.339" (8.6)	15,000 PSI 1030 bar
1/4" FNPT	20	1.38" (35.1)	1.00" (25.4)	0.437" (11.1)	20B	1.75" (44.5)	0.37" (9.4)	0.375" (9.5)	15,000 PSI 1030 bar
3/8" FNPT	21	1.38" (35.1)	1.00" (25.4)	0.500" (12.7)	21B	1.75" (44.5)	1.06" (26.9)	0.375" (9.5)	15,000 PSI 1030 bar
1/2" FNPT	22	1.38" (35.1)	1.00" (25.4)	0.500" (12.7)	22B	1.75" (44.5)	1.11" (28.2)	0.375" (9.5)	15,000 PSI 1030 bar
3/4" FNPT	41	1.38" (35.1)	1.10" (27.9)	0.500" (12.7)	41B	1.75" (44.5)	1.17" (29.7)	0.375" (9.5)	10,000 PSI 690 bar
1" FNPT	45	1.75" (44.5)	1.75" (44.5)	0.500" (12.7)	45B	1.75" (44.5)	1.75" (44.5)	0.500" (12.7)	10,000 PSI 690 bar

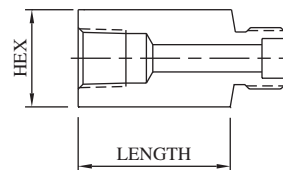

MALE PIPE

Connection	For Side Connections				For Bottom Connection				MAWP*
	Suffix	Hex	Length	Port	Suffix	Hex	Length	Port	
1/8" MNPT	4	1.38" (35.1)	1.08" (27.4)	0.187" (4.7)	4B	1.75" (44.5)	1.09" (27.7)	0.187" (4.7)	15,000 PSI 1030 bar
1/4" MNPT	5	1.38" (35.1)	1.22" (31.0)	0.250" (6.4)	5B	1.75" (44.5)	1.31" (33.3)	0.250" (6.4)	15,000 PSI 1030 bar
3/8" MNPT	6	1.38" (35.1)	1.23" (31.2)	0.375" (9.5)	6B	1.75" (44.5)	1.43" (36.3)	0.375" (9.5)	15,000 PSI 1030 bar
1/2" MNPT	7	1.38" (35.1)	1.59" (40.4)	0.375" (9.5)	7B	1.75" (44.5)	1.63" (41.4)	0.375" (9.5)	15,000 PSI 1030 bar
3/4" MNPT	55	1.38" (35.1)	1.62" (41.1)	0.500" (12.7)	55B	1.75" (44.5)	1.65" (41.9)	0.375" (9.5)	10,000 PSI 690 bar
1" MNPT	56	1.50" (38.1)	1.87" (47.5)	0.500" (12.7)	56B	1.75" (44.5)	1.90" (48.3)	0.375" (9.5)	10,000 PSI 690 bar

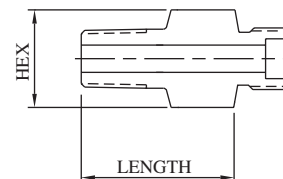

***CAUTION:** The maximum allowable working pressure (MAWP) of the valve shall not exceed the MAWP of the valve series or the selected connection, whichever is less.

All dimensions are for reference only and are subject to change.
 Dimensions in parentheses are millimeters (mm).



上海兆帕流体动力有限公司 / Shanghai MPA Fluid Power Co.,Ltd.
 Web: www.mpapower.com / E-mail: info@mpapower.com

10,000 PSI (690 BAR) 5-WAY TRUNNION VALVES

Model No. **5K106**

FEMALE SINGLE-FERRULE TUBE

Connection	For Side Connections				For Bottom Connection				MAWP*
	Suffix	Hex	Length	Port	Suffix	Hex	Length	Port	
1/4" SL/P	13	1.38" (35.1)	0.64" (16.3)	0.187" (4.7)	13B	1.75" (44.5)	0.66" (16.8)	0.187" (4.7)	11,500 PSI 790 bar
3/8" SL/P	14	1.38" (35.1)	0.75" (19.1)	0.312" (7.9)	14B	1.75" (44.5)	0.75" (19.1)	0.312" (7.9)	7,500 PSI 520 bar
1/2" L/P	15	1.38" (35.1)	1.06" (26.9)	0.437" (11.1)	15B	1.75" (44.5)	1.06" (26.9)	0.375" (9.5)	5,500 PSI 380 bar

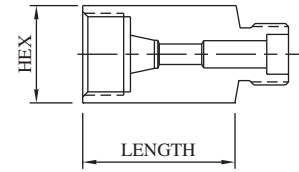

FEMALE M/P CONED AND THREADED TUBE

Connection	For Side Connections				For Bottom Connection				MAWP*
	Suffix	Hex	Length	Port	Suffix	Hex	Length	Port	
1/4" M/P	16	1.38" (35.1)	0.65" (16.5)	0.109" (2.8)	16B	1.75" (44.5)	1.11" (28.2)	0.109" (2.8)	20,000 PSI 1380 bar
3/8" M/P	17	1.38" (35.1)	1.06" (26.9)	0.203" (5.2)	17B	1.75" (44.5)	1.06" (26.9)	0.203" (5.2)	20,000 PSI 1380 bar
9/16" M/P	18	1.38" (35.1)	1.31" (33.3)	0.312" (7.9)	18B	1.75" (44.5)	1.06" (26.9)	0.312" (7.9)	20,000 PSI 1380 bar
3/4" M/P	32	1.38" (35.1)	1.52" (38.6)	0.437" (11.1)	32B	1.75" (44.5)	1.18" (30.0)	0.375" (9.5)	20,000 PSI 1380 bar
1" M/P	43	1.75" (44.5)	1.91" (48.5)	0.500" (12.7)	43B	1.75" (44.5)	1.99" (50.5)	0.375" (9.5)	20,000 PSI 1380 bar

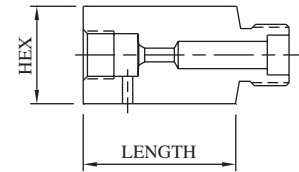

MALE M/P CONED AND THREADED TUBE

Connection	For Side Connections				For Bottom Connection				MAWP*
	Suffix	Hex	Length	Port	Suffix	Hex	Length	Port	
1/4" M/P	8	1.38" (35.1)	1.91" (48.5)	0.109" (2.8)	8B	1.75" (44.5)	1.93" (49.0)	0.109" (2.8)	20,000 PSI 1380 bar
3/8" M/P	10	1.38" (35.1)	1.87" (47.5)	0.203" (5.2)	10B	1.75" (44.5)	2.17" (55.1)	0.203" (5.2)	20,000 PSI 1380 bar
9/16" M/P	11	1.38" (35.1)	3.21" (81.5)	0.312" (7.9)	11B	1.75" (44.5)	2.18" (55.4)	0.312" (7.9)	20,000 PSI 1380 bar
3/4" M/P	37	1.38" (35.1)	3.54" (89.9)	0.437" (11.1)	37B	1.75" (44.5)	5.06" (128.5)	0.437" (11.1)	20,000 PSI 1380 bar
1" M/P	49	1.38" (35.1)	3.20" (81.3)	0.500" (12.7)	49B	1.75" (44.5)	3.25" (82.6)	0.500" (12.7)	20,000 PSI 1380 bar

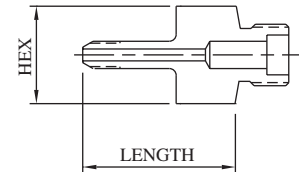

FEMALE H/P CONED AND THREADED TUBE

Connection	For Side Connections				For Bottom Connection				MAWP*
	Suffix	Hex	Length	Port	Suffix	Hex	Length	Port	
1/4" H/P	23	1.38" (35.1)	0.58" (14.7)	0.093" (2.4)	23B	1.75" (44.5)	0.60" (15.2)	0.093" (2.4)	20,000 PSI 1380 bar
3/8" H/P	24	1.38" (35.1)	0.89" (22.6)	0.125" (3.2)	24B	1.75" (44.5)	0.91" (23.1)	0.125" (3.2)	20,000 PSI 1380 bar
9/16" H/P	25	1.50" (38.1)	0.98" (24.9)	0.187" (4.7)	25B	1.75" (44.5)	1.02" (25.9)	0.187" (4.7)	20,000 PSI 1380 bar

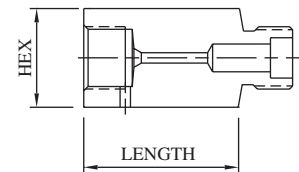

MALE H/P CONED AND THREADED TUBE

Connection	For Side Connections				For Bottom Connection				MAWP*
	Suffix	Hex	Length	Port	Suffix	Hex	Length	Port	
1/4" H/P	9	1.38" (35.1)	2.16" (54.9)	0.083" (2.1)	9B	1.75" (44.5)	2.19" (55.6)	0.083" (2.1)	20,000 PSI 1380 bar
3/8" H/P	30	1.38" (35.1)	2.40" (61.0)	0.125" (3.2)	30B	1.75" (44.5)	2.42" (61.5)	0.125" (3.2)	20,000 PSI 1380 bar
9/16" H/P	42	1.38" (35.1)	2.89" (73.4)	0.187" (4.7)	42B	1.75" (44.5)	2.92" (74.2)	0.187" (4.7)	20,000 PSI 1380 bar

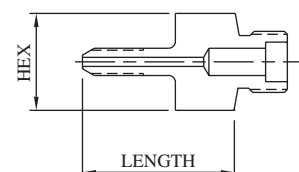

***CAUTION:** The maximum allowable working pressure (MAWP) of the valve shall not exceed the MAWP of the valve series or the selected connection, whichever is less.

All dimensions are for reference only and are subject to change.
Dimensions in parentheses are millimeters (mm).

上海兆帕流体动力有限公司 / Shanghai MPA Fluid Power Co.,Ltd.
Web: www.mpapower.com / E-mail: info@mpapower.com



ACTUATORS

All BuTech ball valves can be fitted with pneumatic or electric actuators for remote control. The following pages show dimensional and technical data for our most popular actuators. Other models are available for unique applications. Please call our sales department for more information.

Available options for actuated valves include:

Visual Monitor

Valve position can be monitored from distances up to 150 ft (45 m)
Specify option **-LB**

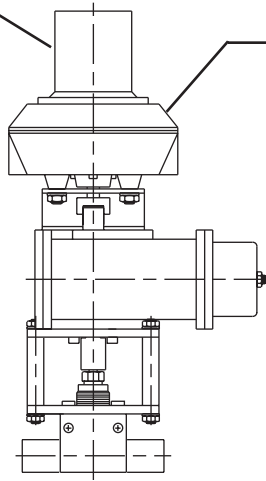

Limit Switches or Solenoid Valves

Two limit switches or solenoid pilot valves can be used for signalling lights, motors, micro-processors or hydraulic valves

Specify option **-L** for limit switches
Specify option **-S** for solenoid valves

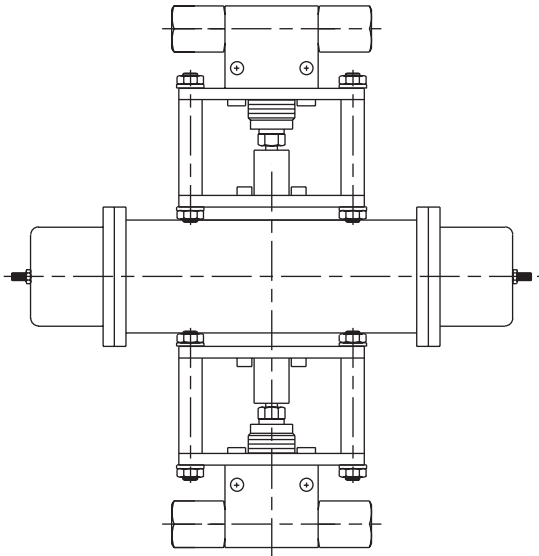

2 Valves / 1 Actuator

BuTech valves can be paired on a single actuator for simultaneous actuation. To order, determine catalog number for ordering a single valve, complete with connection numbers, options and actuator information (see page BV-2), then add the prefix "2"

Example

To specify two K104 valves with 1/4" FNPT connections mounted on a double-acting actuator, the catalog number would be **2K104-20-20-RC10DA**

DOUBLE-ACTING ALUMINUM HOUSING PNEUMATIC ACTUATORS

For valve models beginning **K** or **3DVK**

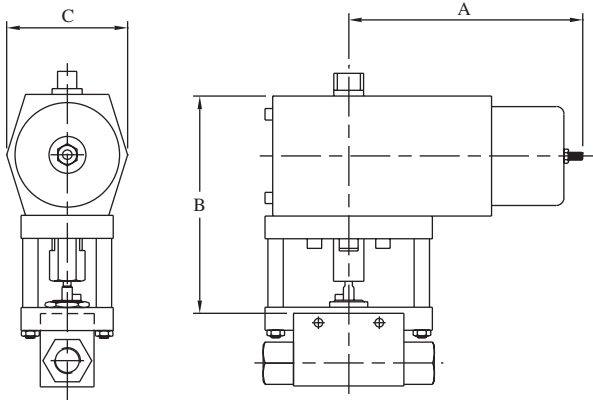

Figure 1

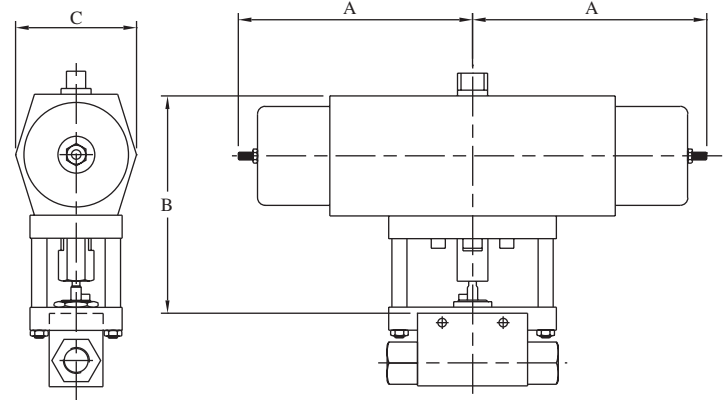

Figure 2

Maximum Air Pressure: 150 PSI (10 bar)

Operating Temperature Range: -20 to 175° F (-29 to 79° C)

Valve Model	Actuator Model	Dimensional Data			Fig.	Air Consumption per Stroke (Free Air)		Required Air Pressure	Opening/Closing Time
		A	B	C		Open	Close		
K34	RA05DA	2.20" (55.9)	5.53" (140.5)	2.60" (66.0)	1	51.0 cu in 836 cc	51.0 cu in 836 cc	80 PSI 5.5 bar	1 sec
K63	RA05DA	2.20" (55.9)	5.53" (140.5)	2.60" (66.0)	1	51.0 cu in 836 cc	51.0 cu in 836 cc	80 PSI 5.5 bar	1 sec
K103	RA05DA	2.20" (55.9)	5.53" (140.5)	2.60" (66.0)	1	51.0 cu in 836 cc	51.0 cu in 836 cc	80 PSI 5.5 bar	1 sec
K104	RA05DA	2.20" (55.9)	6.08" (154.4)	2.60" (66.0)	1	51.0 cu in 836 cc	51.0 cu in 836 cc	80 PSI 5.5 bar	1 sec
K106	RA05DA	2.20" (55.9)	6.08" (154.4)	2.60" (66.0)	1	51.0 cu in 836 cc	51.0 cu in 836 cc	80 PSI 5.5 bar	1 sec
K108	RC20DA	3.85" (97.8)	5.20" (132.1)	3.00" (76.2)	2	64.0 cu in 1049 cc	73.0 cu in 1196 cc	80 PSI 5.5 bar	1 sec
K204	RA05DA	2.20" (55.9)	6.08" (154.4)	2.60" (66.0)	1	51.0 cu in 836 cc	51.0 cu in 836 cc	80 PSI 5.5 bar	1 sec
K206	RA05DA	2.20" (55.9)	6.08" (154.4)	2.60" (66.0)	1	51.0 cu in 836 cc	51.0 cu in 836 cc	80 PSI 5.5 bar	1 sec
3DVK34	RA05DA	2.20" (55.9)	5.60" (142.2)	2.60" (66.0)	1	51.0 cu in 836 cc	51.0 cu in 836 cc	80 PSI 5.5 bar	1 sec
3DVK63	RA05DA	2.20" (55.9)	5.60" (142.2)	2.60" (66.0)	1	51.0 cu in 836 cc	51.0 cu in 836 cc	80 PSI 5.5 bar	1 sec
3DVK93	RA05DA	2.20" (55.9)	5.60" (142.2)	2.60" (66.0)	1	51.0 cu in 836 cc	51.0 cu in 836 cc	80 PSI 5.5 bar	1 sec
3DVK106	RC20DA	3.85" (97.8)	5.20" (132.1)	3.00" (76.2)	2	64.0 cu in 1049 cc	73.0 cu in 1196 cc	80 PSI 5.5 bar	1 sec
3DVK108	RC30DA	5.30" (134.6)	7.00" (177.8)	4.10" (104.1)	1	122.0 cu in 1999 cc	266.0 cu in 4359 cc	80 PSI 5.5 bar	1.5-2.0 sec
3DVK123	RA05DA	2.20" (55.9)	5.78" (146.8)	2.60" (66.0)	1	51.0 cu in 836 cc	51.0 cu in 836 cc	80 PSI 5.5 bar	1 sec
3DVK203	RC10DA	3.85" (97.8)	5.51" (140.0)	2.87" (72.9)	1	32.0 cu in 524 cc	61.0 cu in 1000 cc	80 PSI 5.5 bar	1 sec
3DVK206	RC30DA	5.30" (134.6)	6.82" (173.2)	4.10" (104.1)	1	122.0 cu in 1999 cc	226.0 cu in 3703 cc	80 PSI 5.5 bar	1.5-2.0 sec

All dimensions are for reference only and are subject to change.
Dimensions in parentheses are millimeters (mm).

SPRING-RETURN ALUMINUM HOUSING PNEUMATIC ACTUATORS

For valve models beginning **K** or **3DVK**

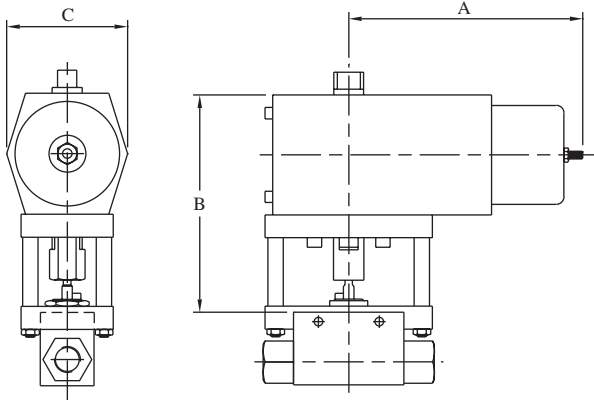

Figure 1

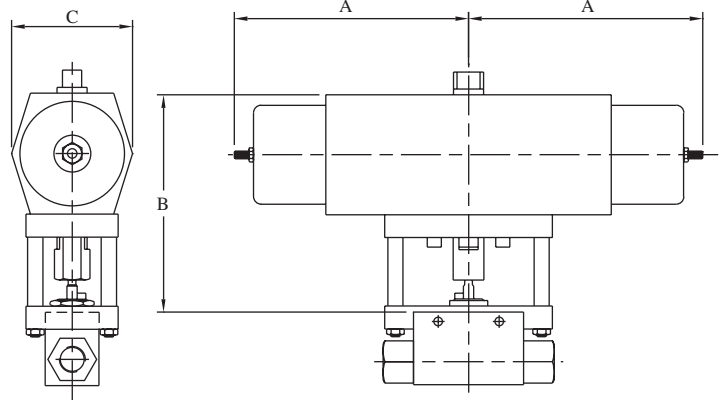

Figure 2

Maximum Air Pressure: 150 PSI (10 bar)

Operating Temperature Range: -20 to 175° F (-29 to 79° C)

Valve Model	Actuator Model	Dimensional Data				Air Consumption per Stroke (Free Air)	Required Air Pressure	Opening/Closing Time
		A	B	C	Fig.			
K34	RA05SR	4.65" (118.1)	5.53" (140.5)	2.60" (66.0)	1	51.0 cu in 836 cc	80 PSI 5.5 bar	1 sec
K63	RA05SR	4.65" (118.1)	5.53" (140.5)	2.60" (66.0)	1	51.0 cu in 836 cc	80 PSI 5.5 bar	1 sec
K103	RA05SR	4.65" (118.1)	5.53" (140.5)	2.60" (66.0)	1	51.0 cu in 836 cc	80 PSI 5.5 bar	1 sec
K104	RC10SR	5.70" (144.8)	6.08" (154.4)	2.60" (66.0)	1	51.0 cu in 836 cc	80 PSI 5.5 bar	1 sec
K106	RC10SR	5.70" (144.8)	6.08" (154.4)	2.60" (66.0)	1	51.0 cu in 836 cc	80 PSI 5.5 bar	1 sec
K108	RC30SR	7.70" (195.6)	7.00" (177.8)	4.10" (104.1)	2	122.0 cu in 1999 cc	80 PSI 5.5 bar	1.5-2.0 sec
K204	RC10SR	5.70" (144.8)	7.00" (177.8)	4.10" (104.1)	1	51.0 cu in 836 cc	80 PSI 5.5 bar	1 sec
K206	RC10SR	5.70" (144.8)	6.08" (154.4)	2.60" (66.0)	1	51.0 cu in 836 cc	80 PSI 5.5 bar	1 sec
3DVK34	RA05SR	4.65" (118.1)	5.60" (142.2)	2.60" (66.0)	1	51.0 cu in 836 cc	80 PSI 5.5 bar	1 sec
3DVK63	RA05SR	4.65" (118.1)	5.60" (142.2)	2.60" (66.0)	1	51.0 cu in 836 cc	80 PSI 5.5 bar	1 sec
3DVK93	RC10SR	4.65" (118.1)	5.60" (142.2)	2.60" (66.0)	1	51.0 cu in 836 cc	80 PSI 5.5 bar	1 sec
3DVK106	RC30SR	7.70" (195.6)	7.07" (179.6)	4.10" (104.1)	1	122.0 cu in 1999 cc	80 PSI 5.5 bar	1.5-2.0 sec
3DVK108	RC40SR	7.70" (195.6)	6.47" (164.3)	4.10" (104.1)	2	244.0 cu in 3998 cc	80 PSI 5.5 bar	1.5-2.0 sec
3DVK123	RC10SR	5.70" (144.8)	5.78" (146.8)	2.60" (66.0)	1	32.0 cu in 524 cc	80 PSI 5.5 bar	1 sec
3DVK203	RC20SR	5.70" (144.8)	5.51" (140.0)	2.87" (72.9)	2	64.0 cu in 1049 cc	80 PSI 5.5 bar	1 sec
3DVK206	RC30SR	7.70" (195.6)	7.00" (177.8)	4.10" (104.1)	1	122.0 cu in 1999 cc	80 PSI 5.5 bar	1.5-2.0 sec

All dimensions are for reference only and are subject to change.
Dimensions in parentheses are millimeters (mm).

DOUBLE-ACTING STAINLESS STEEL HOUSING PNEUMATIC ACTUATORS

For valve models beginning **K** or **3DVK**

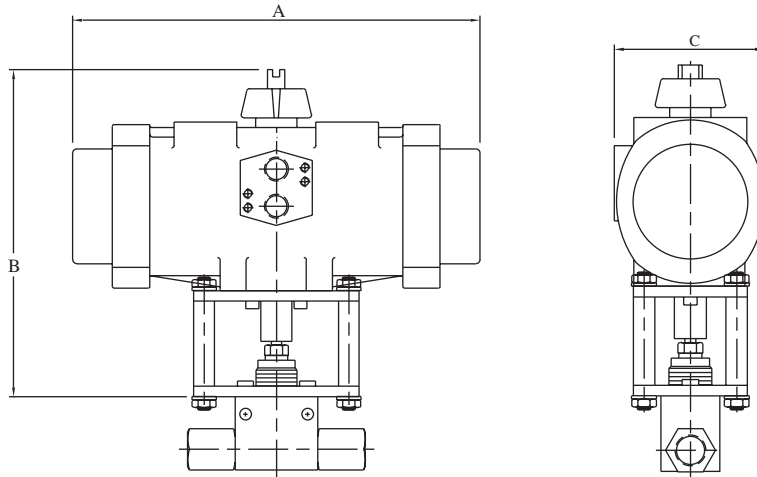

Operating Temperature Range: -20 to 175° F (-29 to 79° C)

Valve Model	Actuator Model	Dimensional Data			Air Consumption per Stroke (Free Air)		Required Air Pressure	Opening/Closing Time
		A	B	C	Open	Close		
K34	RA10DASS	4.19" (106.4)	6.85" (174.0)	3.15" (80.0)	9.0 cu in 147 cc	7.5 cu in 123 cc	15 PSI 1.0 bar	0.15 sec
K63	RA10DASS	4.19" (106.4)	6.85" (174.0)	3.15" (80.0)	9.0 cu in 147 cc	7.5 cu in 123 cc	15 PSI 1.0 bar	0.15 sec
K103	RA10DASS	4.19" (106.4)	6.85" (174.0)	3.15" (80.0)	9.0 cu in 147 cc	7.5 cu in 123 cc	20 PSI 1.4 bar	0.15 sec
K104	RA10DASS	4.19" (106.4)	6.98" (177.3)	3.15" (80.0)	9.0 cu in 147 cc	7.5 cu in 123 cc	20 PSI 1.4 bar	0.15 sec
K106	RA10DASS	4.19" (106.4)	6.98" (177.3)	3.15" (80.0)	9.0 cu in 147 cc	7.5 cu in 123 cc	30 PSI 2.1 bar	0.15 sec
K108	RA20DASS	7.00" (177.8)	7.23" (183.6)	3.82" (97.0)	19.5 cu in 320 cc	17.0 cu in 279 cc	50 PSI 3.4 bar	0.35 sec
K204	RA10DASS	4.19" (106.4)	6.98" (177.3)	3.15" (80.0)	9.0 cu in 147 cc	7.5 cu in 123 cc	30 PSI 2.1 bar	0.15 sec
K206	RA10DASS	4.19" (106.4)	6.98" (177.3)	3.15" (80.0)	9.0 cu in 147 cc	7.5 cu in 123 cc	40 PSI 2.8 bar	0.15 sec
3DVK34	RA10DASS	4.19" (106.4)	6.85" (174.0)	3.15" (80.0)	9.0 cu in 147 cc	7.5 cu in 123 cc	20 PSI 1.4 bar	0.15 sec
3DVK63	RA10DASS	4.19" (106.4)	6.85" (174.0)	3.15" (80.0)	9.0 cu in 147 cc	7.5 cu in 123 cc	20 PSI 1.4 bar	0.15 sec
3DVK93	RA10DASS	4.19" (106.4)	6.85" (174.0)	3.15" (80.0)	9.0 cu in 147 cc	7.5 cu in 123 cc	20 PSI 1.4 bar	0.15 sec
3DVK106	RA20DASS	7.00" (177.8)	7.58" (192.5)	3.82" (97.0)	19.5 cu in 320 cc	17.0 cu in 279 cc	40 PSI 2.8 bar	0.35 sec
3DVK108	RA20DASS	7.00" (177.8)	7.75" (196.9)	3.82" (97.0)	19.5 cu in 320 cc	17.0 cu in 279 cc	60 PSI 4.1 bar	0.35 sec
3DVK123	RA10DASS	4.19" (106.4)	6.98" (177.3)	3.15" (80.0)	9.0 cu in 147 cc	7.5 cu in 123 cc	30 PSI 2.1 bar	0.15 sec
3DVK203	RA10DASS	4.19" (106.4)	6.98" (177.3)	3.15" (80.0)	9.0 cu in 147 cc	7.5 cu in 123 cc	50 PSI 3.4 bar	0.15 sec
3DVK206	RA20DASS	7.00" (177.8)	7.58" (192.5)	3.82" (97.0)	19.5 cu in 320 cc	17.0 cu in 279 cc	50 PSI 3.4 bar	0.35 sec

All dimensions are for reference only and are subject to change.
Dimensions in parentheses are millimeters (mm).

上海兆帕流体动力有限公司 / Shanghai MPA Fluid Power Co.,Ltd.
Web: www.mpapower.com / E-mail: info@mpapower.com



SPRING-RETURN STAINLESS STEEL HOUSING PNEUMATIC ACTUATORS

For valve models beginning **K** or **3DVK**

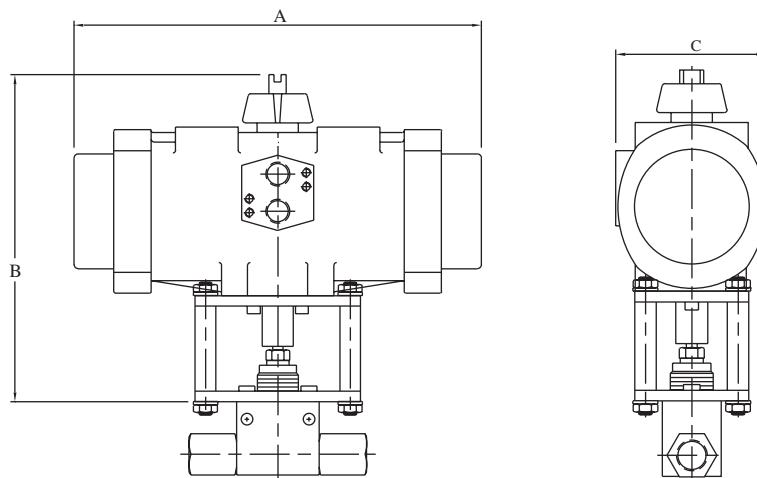

Operating Temperature Range: -20 to 175° F (-29 to 79° C)

Valve Model	Actuator Model	Dimensional Data			Air Consumption per Stroke (Free Air)	Required Air Pressure	Opening/ Closing Time
		A	B	C			
K34	RA10SRSS	5.87" (149.1)	6.85" (174.0)	3.15" (80.0)	9.0 cu in 147 cc	70 PSI 4.8 bar	0.25 sec 0.40 sec
K63	RA10SRSS	5.87" (149.1)	6.85" (174.0)	3.15" (80.0)	9.0 cu in 147 cc	70 PSI 4.8 bar	0.25 sec 0.40 sec
K103	RA10SRSS	5.87" (149.1)	6.85" (174.0)	3.15" (80.0)	9.0 cu in 147 cc	75 PSI 5.2 bar	0.25 sec 0.40 sec
K104	RA10SRSS	5.87" (149.1)	6.98" (177.3)	3.15" (80.0)	9.0 cu in 147 cc	75 PSI 5.2 bar	0.25 sec 0.40 sec
K106	RA10SRSS	5.87" (149.1)	6.98" (177.3)	3.15" (80.0)	9.0 cu in 147 cc	80 PSI 5.5 bar	0.25 sec 0.40 sec
K108	RA30SRSS	11.50" (292.1)	8.73" (221.7)	4.92" (125.0)	52.0 cu in 852 cc	80 PSI 5.5 bar	1.50 sec 2.00 sec
K204	RA10SRSS	5.87" (149.1)	6.98" (177.3)	3.15" (80.0)	9.0 cu in 147 cc	85 PSI 5.9 bar	0.25 sec 0.40 sec
K206	RA10SRSS	5.87" (149.1)	6.98" (177.3)	3.15" (80.0)	9.0 cu in 147 cc	90 PSI 6.2 bar	0.25 sec 0.40 sec
3DVK34	RA10SRSS	5.87" (149.1)	6.85" (174.0)	3.15" (80.0)	9.0 cu in 147 cc	70 PSI 4.8 bar	0.25 sec 0.40 sec
3DVK63	RA10SRSS	5.87" (149.1)	6.85" (174.0)	3.15" (80.0)	9.0 cu in 147 cc	70 PSI 4.8 bar	0.25 sec 0.40 sec
3DVK93	RA10SRSS	5.87" (149.1)	6.85" (174.0)	3.15" (80.0)	9.0 cu in 147 cc	75 PSI 5.2 bar	0.25 sec 0.40 sec
3DVK106	RA30SRSS	11.50" (292.1)	9.18" (233.2)	4.92" (125.0)	52.0 cu in 852 cc	75 PSI 5.2 bar	1.50 sec 2.00 sec
3DVK108	RA30SRSS	11.50" (292.1)	9.25" (235.0)	4.92" (125.0)	52.0 cu in 852 cc	80 PSI 5.5 bar	1.50 sec 2.00 sec
3DVK123	RA10SRSS	5.87" (149.1)	6.98" (177.3)	3.15" (80.0)	9.0 cu in 147 cc	80 PSI 5.5 bar	0.25 sec 0.40 sec
3DVK203	RA20SRSS	8.74" (222.0)	7.57" (192.3)	3.82" (97.0)	19.5 cu in 320 cc	75 PSI 5.2 bar	0.50 sec 1.00 sec
3DVK206	RA30SRSS	11.50" (292.1)	9.08" (230.6)	4.92" (125.0)	52.0 cu in 852 cc	80 PSI 5.5 bar	1.50 sec 2.00 sec

All dimensions are for reference only and are subject to change.
Dimensions in parentheses are millimeters (mm).

DOUBLE-ACTING ALUMINUM HOUSING PNEUMATIC ACTUATORS

For valve models beginning 3K

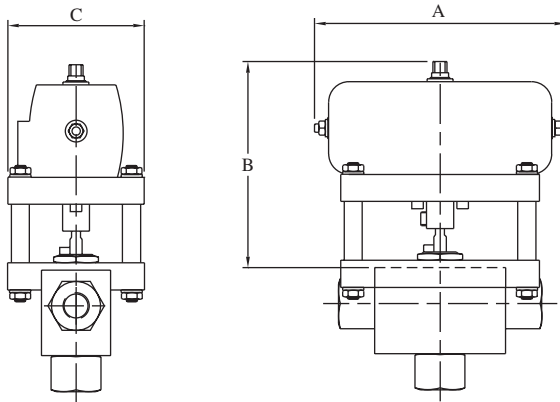

Figure 1

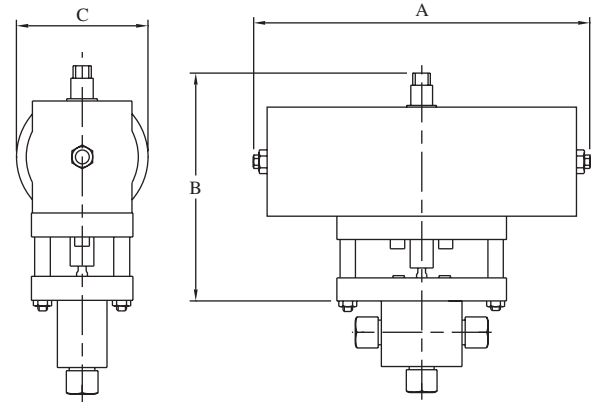

Figure 2

Operating Temperature Range: -20 to 175° F (-29 to 79° C)

Valve Model	Actuator Model	Dimensional Data			Fig.	Air Consumption per Stroke (Free Air)		Required Air Pressure	Opening/ Closing Time
		A	B	C		Open	Close		
3K34	ADA180	6.69" (169.9)	4.87" (123.7)	2.69" (68.3)	1	34.8 cu in 570 cc	52.8 cu in 865 cc	80 PSI 5.5 bar	< 1 sec
3K63	ADA180	6.69" (169.9)	4.87" (123.7)	2.69" (68.3)	1	34.8 cu in 570 cc	52.8 cu in 865 cc	80 PSI 5.5 bar	< 1 sec
3K93	ADA180	6.69" (169.9)	4.87" (123.7)	2.69" (68.3)	1	34.8 cu in 570 cc	52.8 cu in 865 cc	80 PSI 5.5 bar	< 1 sec
3K123	ADA180	6.69" (169.9)	4.93" (125.2)	2.69" (68.3)	1	34.8 cu in 570 cc	52.8 cu in 865 cc	80 PSI 5.5 bar	< 1 sec
3K106	ADA180	6.69" (169.9)	5.70" (144.8)	2.69" (68.3)	1	34.8 cu in 570 cc	52.8 cu in 865 cc	80 PSI 5.5 bar	< 1 sec
3K108	AHDA180	10.92" (277.4)	6.87" (174.5)	3.25" (82.6)	2	128.8 cu in 2111 cc	128.8 cu in 2111 cc	80 PSI 5.5 bar	< 1 sec
3K206	ADA180	6.69" (169.9)	5.70" (144.8)	2.69" (68.3)	1	34.8 cu in 570 cc	52.8 cu in 865 cc	80 PSI 5.5 bar	< 1 sec
3K203	ADA180	6.69" (169.9)	4.93" (125.2)	2.69" (68.3)	1	34.8 cu in 570 cc	52.8 cu in 865 cc	80 PSI 5.5 bar	< 1 sec

All dimensions are for reference only and are subject to change.
Dimensions in parentheses are millimeters (mm).

上海兆帕流体动力有限公司 / Shanghai MPA Fluid Power Co.,Ltd.
Web: www.mpapower.com / E-mail: info@mpapower.com



90° UNI-DIRECTIONAL ELECTRIC ACTUATORS

For valve models beginning **K** or **3K**

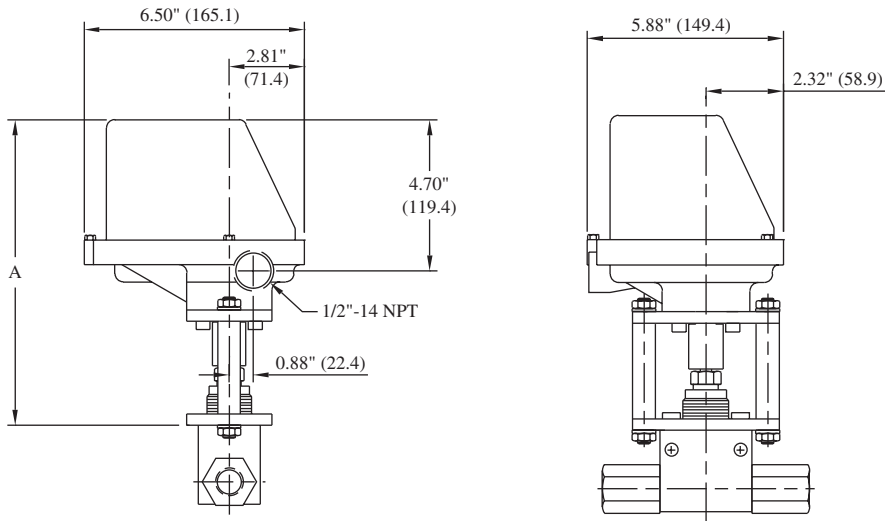

Valve Model	110/120 VAC 50/60 Hz	210/220 VAC 50/60 Hz	A	Opening/ Closing Time
K34	WE110	WE220	8.19" (208.0)	5 sec
K63 / K103	WE110	WE220	8.19" (208.0)	5 sec
K104 / K204	WE110	WE220	8.19" (208.0)	5 sec
K106 / K206	WE110	WE220	8.19" (208.0)	5 sec
K108	WHE110	WHE220	8.10" (205.7)	9 sec
3K34	WE110	WE220	8.19" (208.0)	5 sec
3K63 / 3K93	WE110	WE220	8.19" (208.0)	5 sec
3K123	WE110	WE220	8.19" (208.0)	5 sec
3K203	WE110	WE220	8.00" (203.2)	5 sec
3K106 / 3K206	WE110	WE220	8.25" (209.6)	5 sec
3K108	WHE110	WHE220	8.10" (205.7)	9 sec

Operating Temperature Range: 0 to 150° F (-18 to 65° C)

All dimensions are for reference only and are subject to change.
Dimensions in parentheses are millimeters (mm).

2-WAY TRUNNION VALVE

BuTech offers a 2-way trunnion valve for severe high cycle applications. These valves are constructed of the same materials as our 3-way diverting and switching valves and are designed to operate in temperatures of -20 to 400° F (-28 to 204° C). For operating at temperatures up to 550° F (288° C), specify our high temperature option (see page BV-2).

Features:

- Pressures to 20,000 PSI (1380 bar) at 72°F (22°C)
- Pressure loaded seats assure positive sealing
- Blowout-proof stem provides maximum safety
- Choice of replaceable connections for installation versatility
- Double-ended trunnion mounted ball
- Reinforced PEEK trunnion bearings and high-temperature o-rings for temperatures up to 550°F (288°C)
- Bi-directional flow capabilities

Available Models:

Model No.	Maximum Pressure*	Port	Cv	Page
3K341	3,000 PSI 210 bar	0.250" (6.4 mm)	1.40	BV-21
3K631	6,000 PSI 410 bar	0.187" (4.7 mm)	0.75	BV-22
3K931	10,000 PSI 690 bar	0.187" (4.7 mm)	0.75	BV-24
3K1061	10,000 PSI 690 bar	0.375" (9.5 mm)	3.40	BV-26
3K1081	10,000 PSI 690 bar	0.500" (12.7 mm)	10.00	BV-28
3K1231	12,000 PSI 830 bar	0.187" (4.7 mm)	0.75	BV-30
3K2031	20,000 PSI 1380 bar	0.187" (4.7 mm)	0.75	BV-32
3K2061	20,000 PSI 1380 bar	0.375" (9.5 mm)	3.40	BV-34

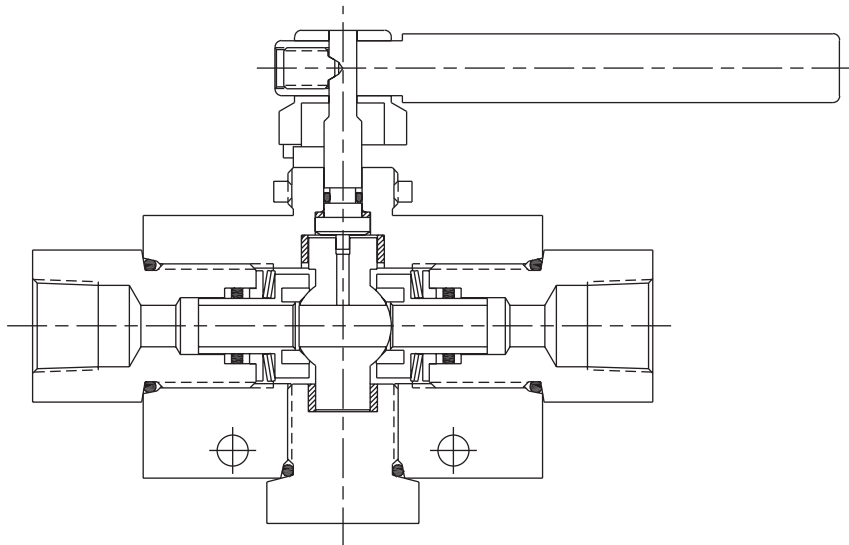

***CAUTION:** The maximum allowable working pressure (MAWP) of the valve shall not exceed the MAWP of the valve series or the selected connection, whichever is less.

All dimensions are for reference only and are subject to change.
Dimensions in parentheses are millimeters (mm).

上海兆帕流体动力有限公司 / Shanghai MPA Fluid Power Co.,Ltd.
Web: www.mpapower.com / E-mail: info@mpapower.com



6000 PSI (410 BAR) 2-WAY BALL VALVES

BuTech ball valves are available in female NPT connections and are available with special seal materials or manufactured from any machinable metal for extreme applications.

Materials of Construction:

- 316 cold-worked stainless steel body and side adapter
- 316 cold-worked stem
- PEEK ball seals
- Teflon back-ups
- Viton O-rings

Applications:

- All types of instrumentation
- Laboratories
- Refineries
- Hydraulic and pneumatic piping
- Gauge shut-off and vent
- Control panels
- Chemical research
- Food processing
- Pilot plants
- Water blasting
- Test stands

Features:

- Pressures to 6,000 PSI (410 bar) at 72°F (22°C)
- Pressure loaded seats assure positive sealing
- Blowout-proof stem and ball provide maximum safety
- Choice of replaceable connections for installation versatility
- Straight-through flow path minimizes pressure drop
- Quarter-turn operation accommodates quick open and close needs
- Flow indicating handle indicates valve position at a glance
- Bi-directional flow capabilities

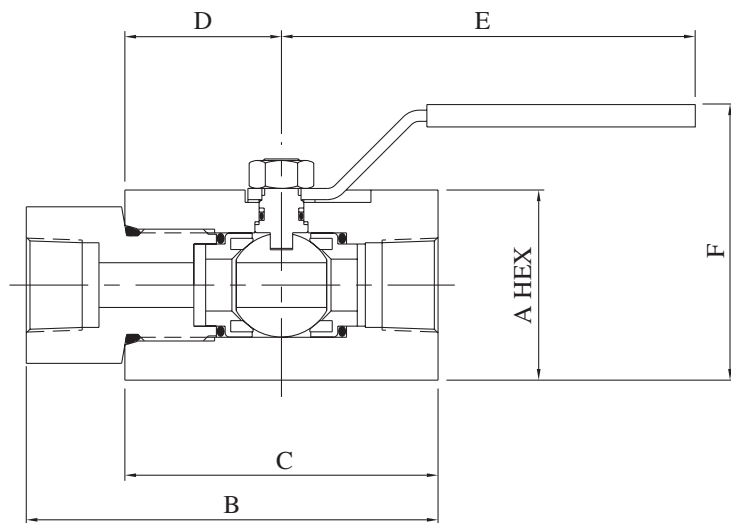

Catalog Number	Connection	Port	Cv	A	B	C	D	E	F
H64	3/8" NPT	0.250" (6.4)	1.40	1.37" (34.8)	3.09" (78.5)	2.25" (57.2)	1.00" (25.4)	3.75" (95.3)	2.06" (52.3)
H66	1/2" NPT	0.375" (9.5)	3.40	1.75" (44.5)	3.95" (100.3)	3.00" (76.2)	1.37" (34.8)	4.50" (114.3)	2.66" (67.6)
H68	3/4" NPT	0.500" (12.7)	10.00	2.12" (53.8)	4.60" (116.8)	3.50" (88.9)	1.75" (44.5)	4.50" (114.3)	2.89" (73.4)

All dimensions are for reference only and are subject to change.
Dimensions in parentheses are millimeters (mm).